

# ***DrayTek***

## VigorAP 1000C

802.11ac Ceiling-mount AP



## USER'S GUIDE

V1.3

# **VigorAP 1000C**

---

802.11ac Ceiling-mount AP

User's Guide

Version: 1.3

Firmware Version: V1.4.0

Date: April 23, 2021

# Intellectual Property Rights (IPR) Information

---

## Copyrights

© All rights reserved. This publication contains information that is protected by copyright. No part may be reproduced, transmitted, transcribed, stored in a retrieval system, or translated into any language without written permission from the copyright holders.

## Trademarks

The following trademarks are used in this document:

- Microsoft is a registered trademark of Microsoft Corp.
- Windows, Windows 10 and Explorer are trademarks of Microsoft Corp.
- Apple and Mac OS are registered trademarks of Apple Inc.
- Other products may be trademarks or registered trademarks of their respective manufacturers.

# Safety Instructions and Approval

---

## Safety Instructions

- Read the installation guide thoroughly before you set up the modem.
- The modem is a complicated electronic unit that may be repaired only be authorized and qualified personnel. Do not try to open or repair the modem yourself.
- Do not place the modem in a damp or humid place, e.g. a bathroom.
- The modem should be used in a sheltered area, within a temperature range of +5 to +40 Celsius.
- Do not expose the modem to direct sunlight or other heat sources. The housing and electronic components may be damaged by direct sunlight or heat sources.
- Do not deploy the cable for LAN connection outdoor to prevent electronic shock hazards.
- Keep the package out of reach of children.
- When you want to dispose of the modem, please follow local regulations on conservation of the environment.

## Warranty

We warrant to the original end user (purchaser) that the modem will be free from any defects in workmanship or materials for a period of two (2) years from the date of purchase from the dealer. Please keep your purchase receipt in a safe place as it serves as proof of date of purchase. During the warranty period, and upon proof of purchase, should the product have indications of failure due to faulty workmanship and/or materials, we will, at our discretion, repair or replace the defective products or components, without charge for either parts or labor, to whatever extent we deem necessary to restore the product to proper operating condition. Any replacement will consist of a new or re-manufactured functionally equivalent product of equal value, and will be offered solely at our discretion. This warranty will not apply if the product is modified, misused, tampered with, damaged by an act of God, or subjected to abnormal working conditions. The warranty does not cover the bundled or licensed software of other vendors. Defects which do not significantly affect the usability of the product will not be covered by the warranty. We reserve the right to revise the manual and online documentation and to make changes from time to time in the contents hereof without obligation to notify any person of such revision or changes.

## Be a Registered Owner

Web registration is preferred. You can register your Vigor router via <https://myvigor.draytek.com>.

## Firmware & Tools Updates

Due to the continuous evolution of DrayTek technology, all modems will be regularly upgraded. Please consult the DrayTek web site for more information on newest firmware, tools and documents. <https://www.draytek.com>

# Table of Contents

<b>Chapter I Installation .....</b>	<b>VII</b>
I-1 Introduction .....	1
I-1-1 LED Indicators and Connectors .....	2
I-2 Hardware Installation .....	4
I-3 Network IP Configuration .....	8
I-3-1 Windows 10 IP Address Setup .....	8
I-4 Accessing to Web User Interface .....	11
I-5 Changing Password .....	14
I-6 Dashboard .....	15
I-7 Quick Start Wizard .....	16
I-7-1 Settings for Access Point .....	17
I-7-2 Settings for Mesh Root .....	20
I-7-3 Settings for Mesh Node .....	26
I-7-4 Settings for Range Extender .....	27
<b>Chapter II Connectivity .....</b>	<b>33</b>
II-1 Operation Mode .....	34
II-2 General Concepts for Wireless LAN .....	36
II-3 Wireless LAN (2.4GHz/5GHz/5GHz-2) Settings for AP Mode .....	39
II-3-1 General Setup .....	40
II-3-2 Security .....	43
II-3-3 Access Control .....	46
II-3-4 WPS .....	47
II-3-5 Advanced Setting .....	49
II-3-6 AP Discovery .....	51
II-3-7 WDS AP Status .....	52
II-3-8 Bandwidth Management .....	52
II-3-9 Airtime Fairness .....	53
II-3-10 Station Control .....	55
II-3-11 Roaming .....	57
II-3-12 Band Steering (for Wireless LAN (2.4GHz)) .....	59
II-3-13 Station List .....	64
II-4 Mesh Settings for Mesh Mode .....	70
II-4-1 Mesh Setup .....	72
II-4-2 Mesh Status .....	78
II-4-3 Mesh Discovery .....	79
II-4-4 Basic Configuration Sync .....	80
II-4-5 Advanced Config Sync .....	83
II-5 Universal Repeater Settings for Range Extender Mode .....	85
II-6 LAN .....	89
II-6-1 General Setup .....	89
II-6-2 Port Settings .....	92
<b>Chapter III Management .....</b>	<b>93</b>
III-1 System Maintenance .....	94
III-1-1 System Status .....	95
III-1-2 TR-069 .....	97
III-1-3 Administrator Password .....	99

III-1-4 User Password.....	100
III-1-5 Configuration Backup.....	101
III-1-6 Syslog/Mail Alert.....	103
III-1-7 Time and Date.....	104
III-1-8 SNMP.....	106
III-1-9 Management.....	107
III-1-10 Reboot System.....	109
III-1-11 Firmware Upgrade.....	110
III-2 Central AP Management.....	111
III-2-1 General Setup.....	111
III-2-2 APM Log.....	112
III-2-3 Overload Management.....	113
III-2-4 Status of Settings.....	114
III-3 Mobile Device Management.....	116
III-3-1 Station List.....	116
III-3-2 Station Statistics.....	122
III-3-3 Station Nearby.....	123
III-3-4 Policies.....	124
III-3-5 Station Control List.....	125
<b>Chapter IV Others .....</b>	<b>127</b>
IV-1 RADIUS Setting.....	128
IV-1-1 RADIUS Server.....	128
IV-1-2 Certificate Management.....	129
IV-2 Applications.....	132
IV-2-1 Schedule.....	132
IV-2-2 Apple iOS Keep Alive.....	135
IV-2-3 Wi-Fi Auto On/Off.....	136
IV-2-4 Sensor.....	137
<b>Chapter V Mobile APP, DrayTek Wireless.....</b>	<b>139</b>
V-1 Introduction of DrayTek Wireless.....	140
V-2 Select a VigorAP.....	141
V-3 Quick Start Wizard.....	142
V-4 Login.....	151
<b>Chapter VI Troubleshooting.....</b>	<b>155</b>
VI-1 Diagnostics.....	156
VI-1-1 System Log.....	157
VI-1-2 Speed Test.....	157
VI-1-3 Traffic Graph.....	158
VI-1-4 Where am I.....	158
VI-1-5 WLAN (2.4GHz) Statistics.....	159
VI-1-6 WLAN (5GHz) Statistics.....	160
VI-1-7 WLAN (5GHz-2) Statistics.....	161
VI-1-8 Interference Monitor.....	162
VI-1-9 Support Area.....	164
VI-2 Checking the Hardware Status.....	165
VI-3 Checking the Network Connection Settings.....	166
VI-3-1 For Windows.....	166
VI-3-2 For Mac Os.....	168
VI-4 Pinging the Device.....	169
VI-4-1 For Windows.....	169
VI-4-2 For Mac Os (Terminal).....	169

VI-5 Backing to Factory Default Setting.....	171
VI-5-1 Software Reset.....	171
VI-5-2 Hardware Reset.....	171
VI-6 Contacting DrayTek .....	172
Index .....	173

# Chapter I Installation







# I-1 Introduction

---

This is a generic International version of the user guide. Specification, compatibility and features vary by region. For specific user guides suitable for your region or product, please contact local distributor.

---

Thank you for purchasing this VigorAP 1000C!

As a tri-band AP, it provides an extra 5GHz Wireless band which increases the supported number of wireless devices. In Mesh mode or Range Extender mode, this extra band can also be dedicated as the Uplink band to the Internet. VigorAP 1000C is suitable to construct a small Wireless network.



VigorAP 1000C can operate in standalone mode for your office network or a classroom; connected to your LAN and offering you wireless access.

It makes high density with quality-performance be feasible for users as it is going to be implemented with DrayTek VigorACS 2 supports configuration, firmware upgrade, status, and monitoring.

The Power of Ethernet (PoE) on VigorAP 1000C relieves the installation of the power plug. The massive deployment of VigorAP 1000C for hospitalities and school environment will be much easier.

With the optimized antennas built-in, DrayTek VigorAP 1000C ceiling-mount wireless access point is ideal for hospitalities, small offices, and small campus.

Easy install procedures allows any computer users to setup a network environment in very short time - within minutes, even inexperienced users. Just follow the instructions given in this user manual, you can complete the setup procedure and release the power of this access point all by yourself!

## I-1-1 LED Indicators and Connectors

Before you use the Vigor modem, please get acquainted with the LED indicators and connectors first.

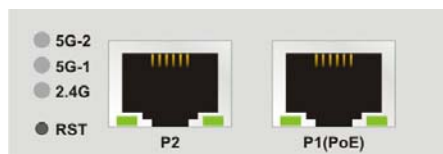



LED	Status	Explanation
5G-2 / 5G-1 / 2.4G	On	Wireless function is ready.
	Off	Wireless function is not ready.
	Blinking	Data is transmitting (sending/receiving).
P2 / P1(PoE) (Left LED)	On	The LAN port is connected.
	Off	LAN is disconnected.
	Blinking	Data is transmitting (sending/receiving).
P2 / P1(PoE) (Right LED)	On	A normal connection (rate with 1000M) is through its corresponding port.
	Off	The LAN port is connected with a transmission rate of 10/100Mbps if left LED is on.

**i Note:**

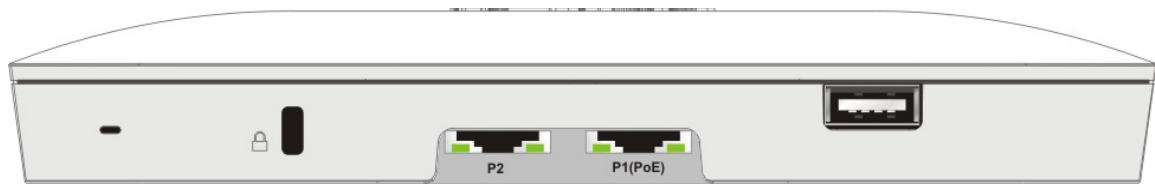
Connector P1(PoE) is used for PoE connection (for indoor use only).



Interface	Description
RST	Restore the default settings. Usage: Switch on the access point. Press and hold reset button for at least 5 seconds. VigorAP will restart with the factory default configuration.
P2/P1(PoE)	Connectors for local networked devices.
 USB	A connector for a USB device.
	A security hole for installing the anti-theft lock.

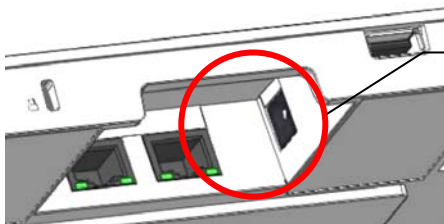

The PWR connector (next to connector P1(PoE)) for a power adapter.

# I-2 Hardware Installation

This section will guide you through installing the VigorAP.

**Note:**

For the sake of personal safety, only trained and qualified personnel should install this access point.

VigorAP can be mounted on the board of calcium silicate. Below shows an exploded view of VigorAP installation.

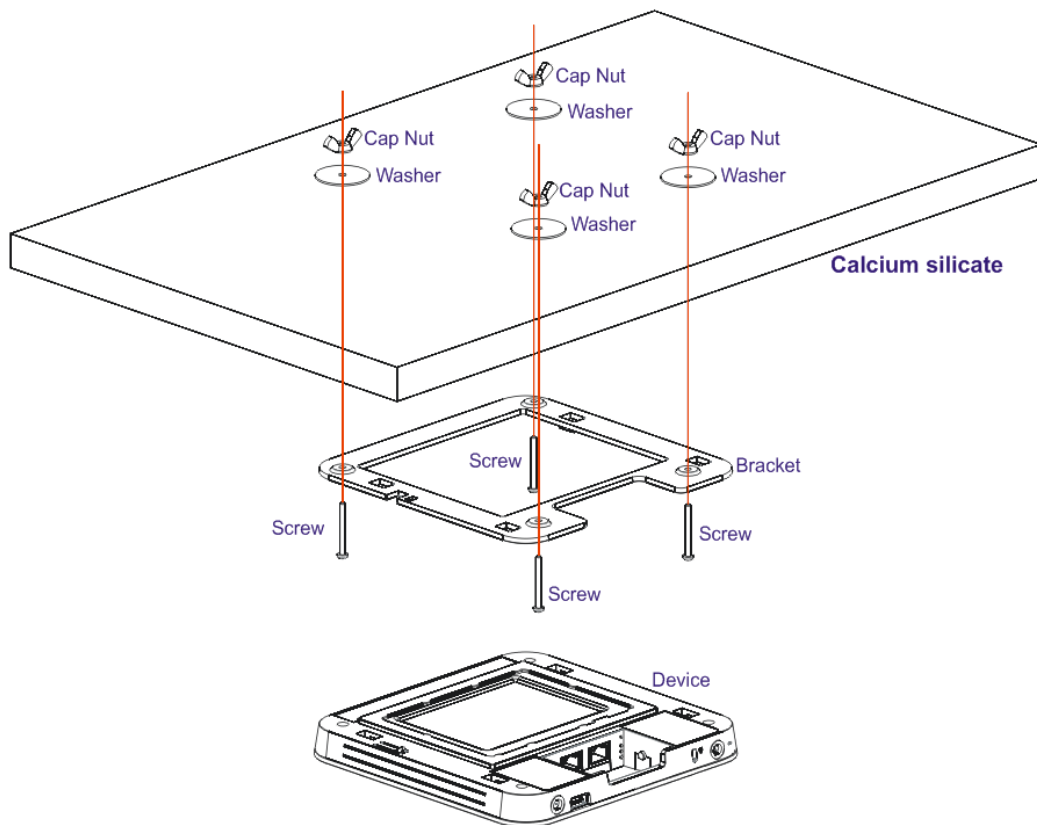

Follow the steps listed below to mount the access point.

1. Place the bracket on the front side of the calcium silicate board and fasten it with four screws.

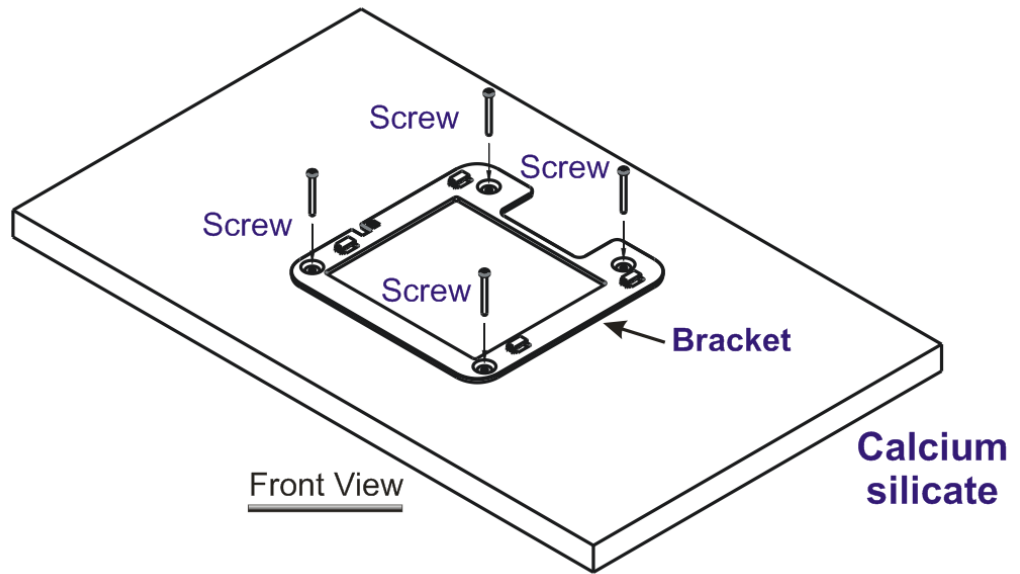

2. When the bracket is in place, reverse the board. Put the washer on the screw.

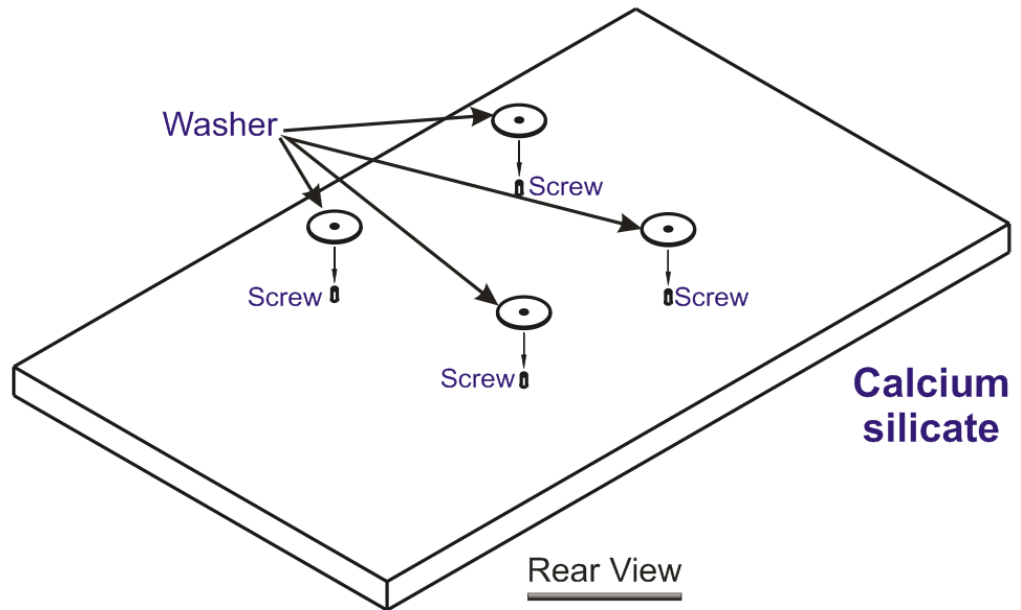

3. Insert the cap nut to the screw on the washer. Rotate the cap nut until it locks firmly on the washer.

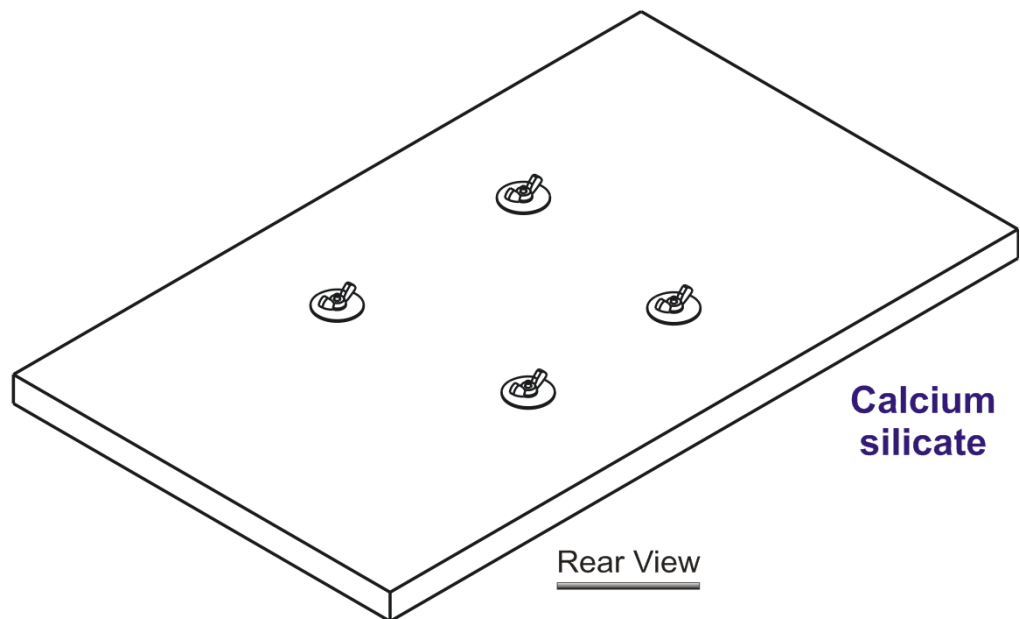
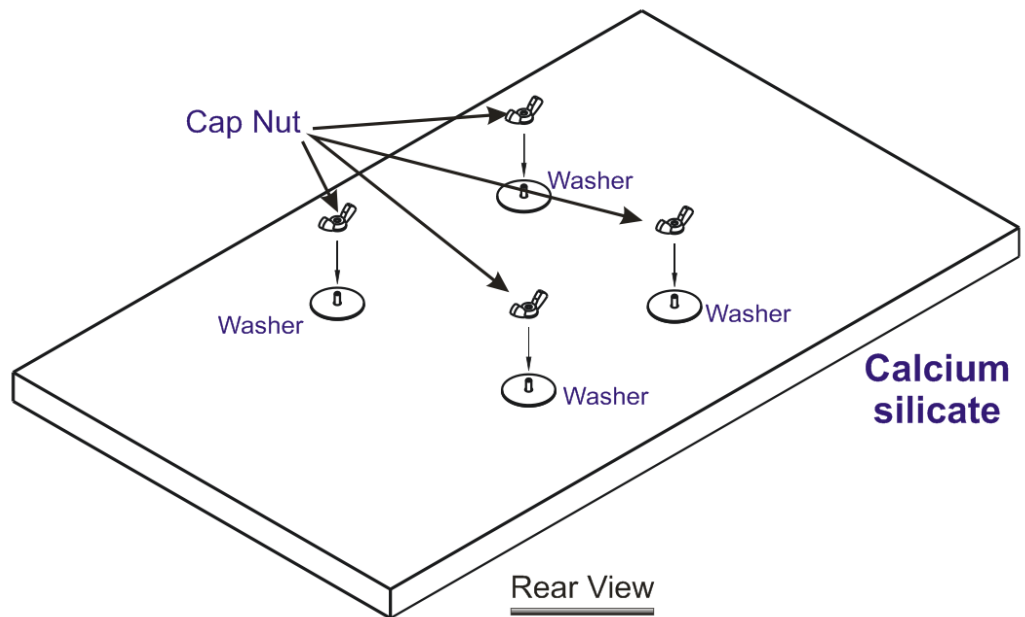

4. There are four latches on the bracket. Put the device (VigorAP) on the bracket with the direction shown below.

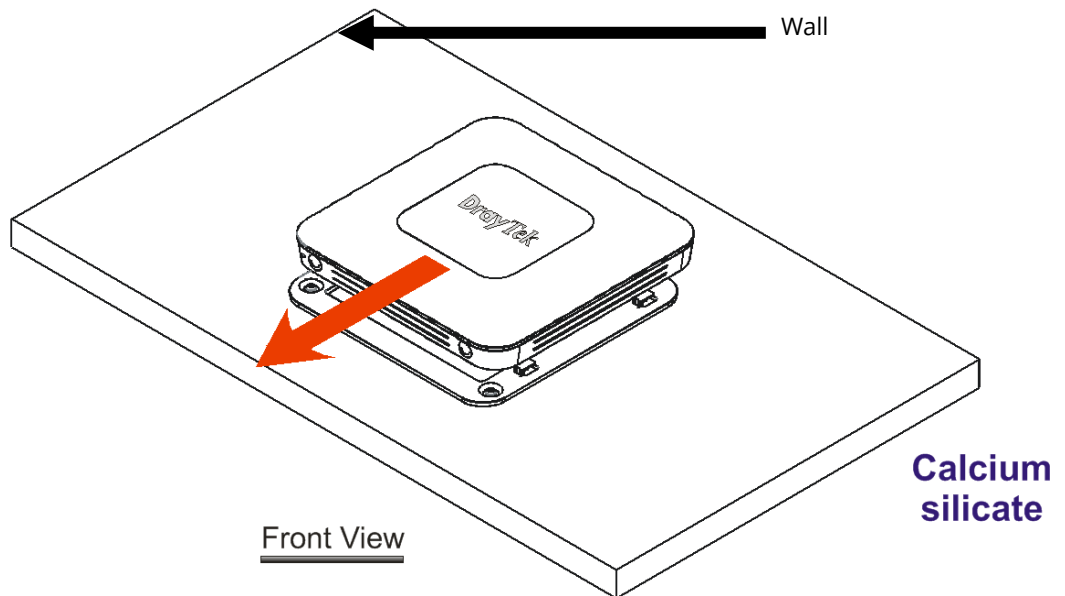
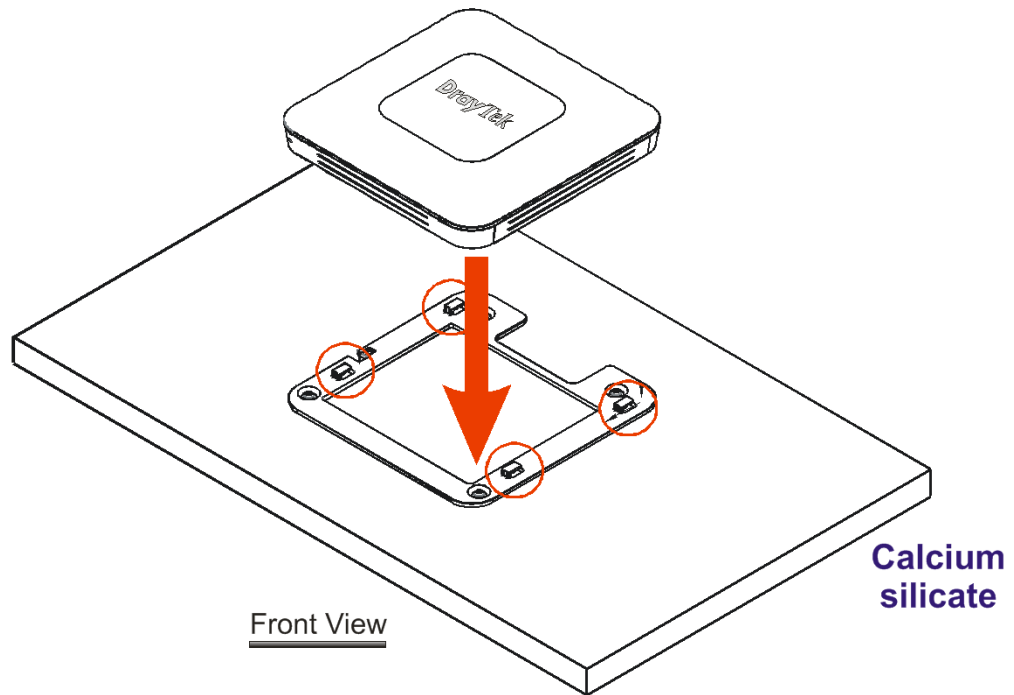

# I-3 Network IP Configuration

After the network connection is built, the next step you should do is setup VigorAP 1000C with proper network parameters, so it can work properly in your network environment.

Before you can connect to the access point and start configuration procedures, your computer must be able to get an IP address in the same subnet as this AP. If it's not connected to the same DHCP Server with the AP or you're unsure, please follow the following instructions to configure your computer to use the static IP address in the same subnet as default IP address of this AP.

For the default IP address of this AP is set "192.168.1.2", we recommend you to use "192.168.1.X (except 2)" in the field of IP address on this section for your computer.

***If the operating system of your computer is...***

**Windows 10** - please go to section I-3-1

## I-3-1 Windows 10 IP Address Setup

Click the **Start** button (it should be located at lower-left corner of your computer), then click the **Settings** icon.

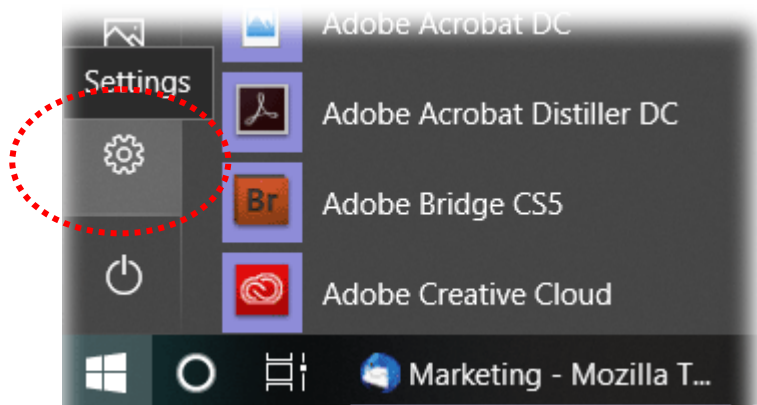

Double-click **Network & Internet**.

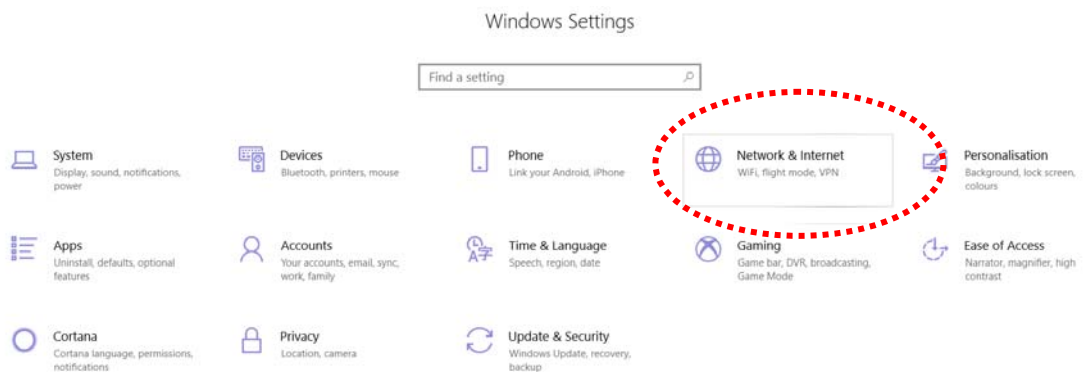



Next, click **Change adapter options**.

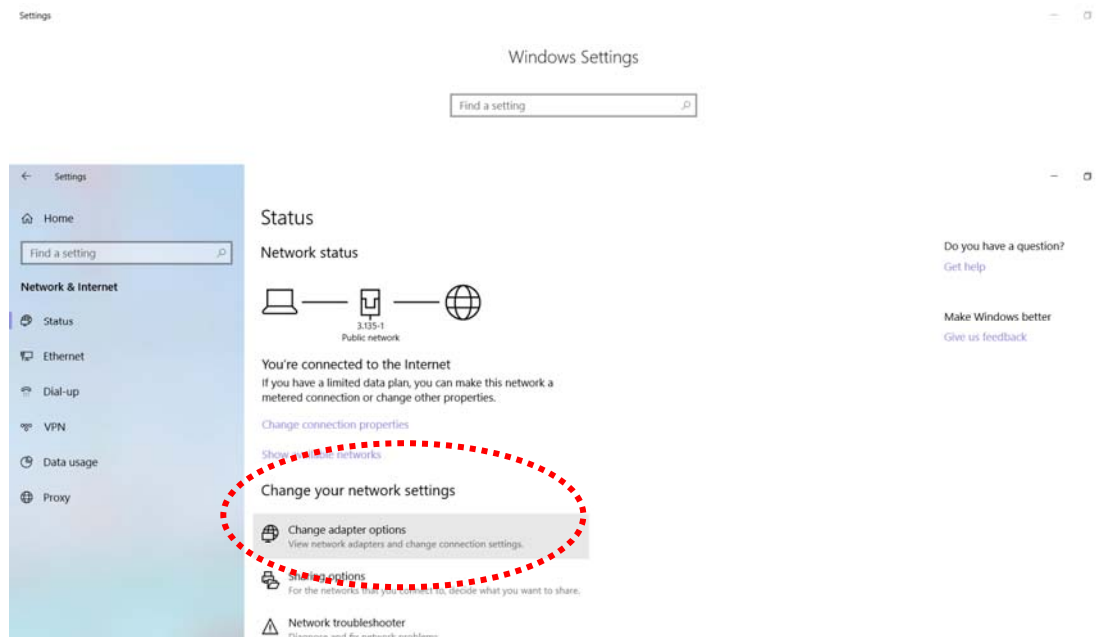

Click the local area connection.

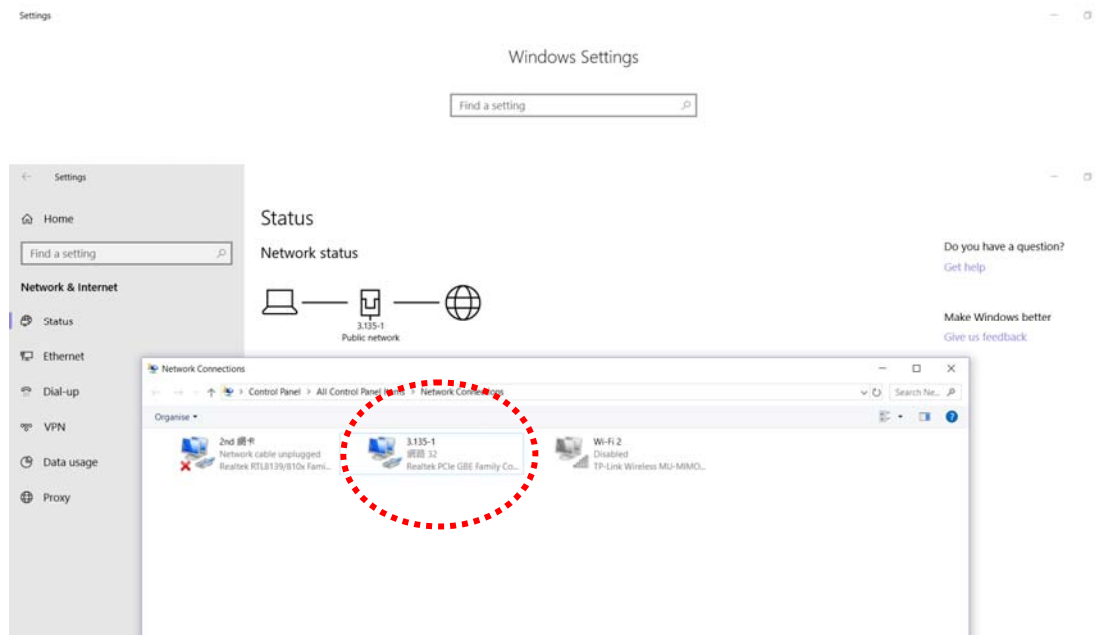

Then, select **Internet Protocol Version 4 (TCP/IPv4)** and click **Properties**.

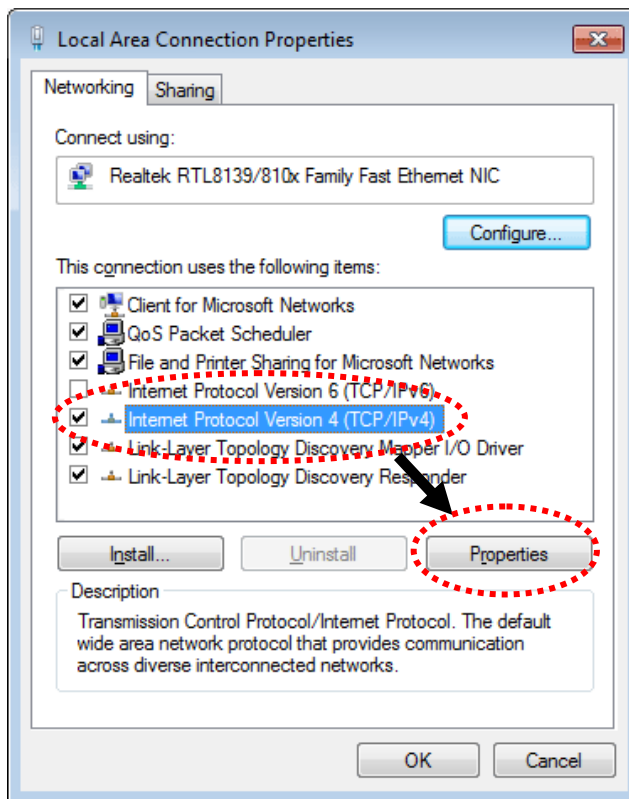

Under the General tab, click **Use the following IP address**. Then input the following settings in respective field and click **OK** when finish.

IP address: **192.168.1.9**

Subnet Mask: **255.255.255.0**

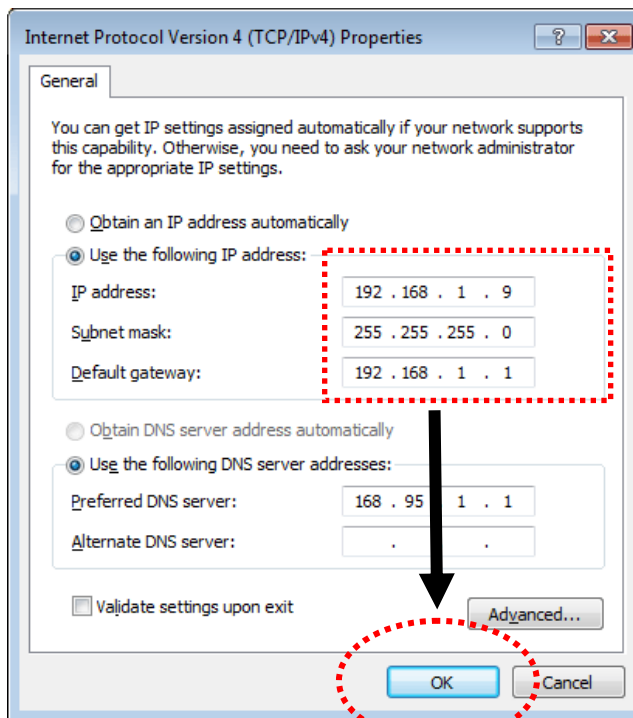

## I-4 Accessing to Web User Interface

---

All functions and settings of this access point must be configured via web user interface. Please start your web browser (e.g., Firefox).

1. Make sure your PC connects to the VigorAP 1000C correctly.
2. Open a web browser on your PC and type **http://192.168.1.2**. A pop-up window will open to ask for username and password. Please type "admin/admin" on Username/Password and click **OK**.

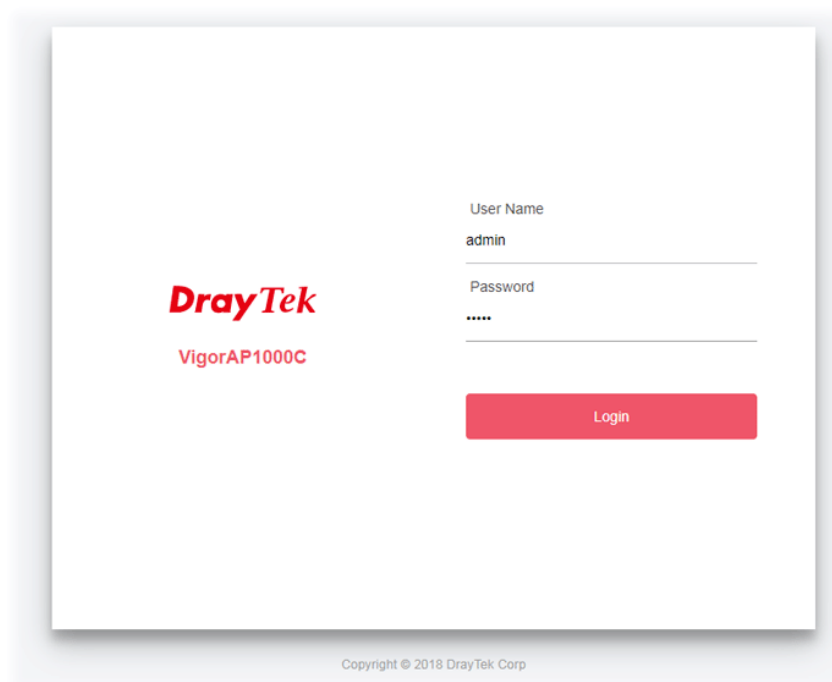

---

**i** Note:

You may either simply set up your computer to get IP dynamically from the router or set up the IP address of the computer to be in the same subnet as **the IP address of VigorAP 1000C**.

- If there is no DHCP server on the network, then VigorAP 1000C will have an IP address of 192.168.1.2.
  - If there is DHCP available on the network, then VigorAP 1000C will receive its IP address via the DHCP server.
  - If you connect to VigorAP by wireless LAN, you could try to access the web user interface through <http://vigorap.com>.
-

- For the first time accessing VigorAP, the **Quick Start Wizard** for configuring wireless settings will appear as follows. Refer to [Section I-7 Quick Start Wizard for detailed information](#).

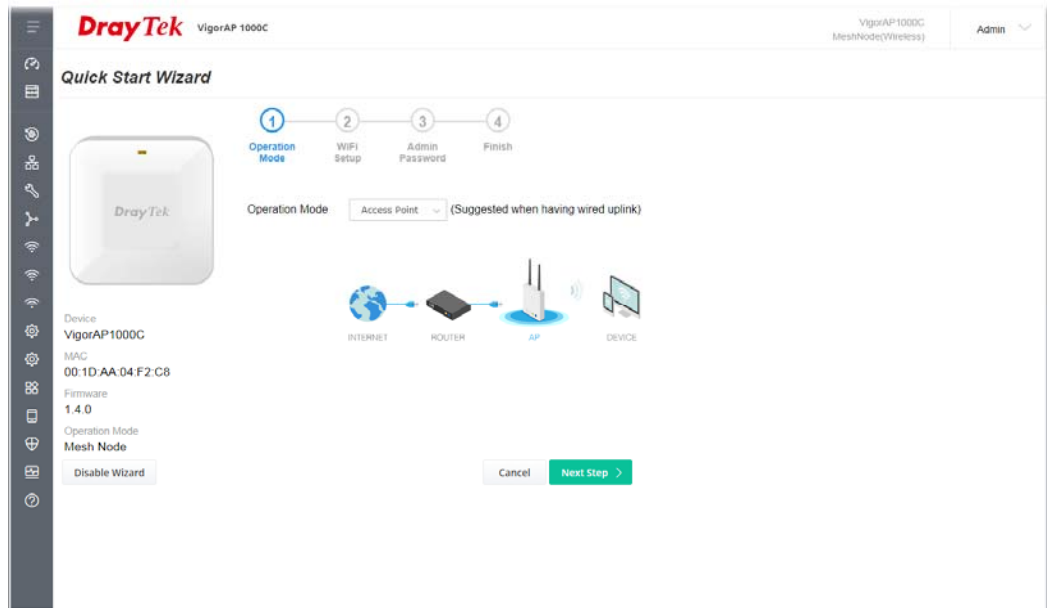

- If VigorAP has been configured previously, the Dashboard of VigorAP will appear as follows:

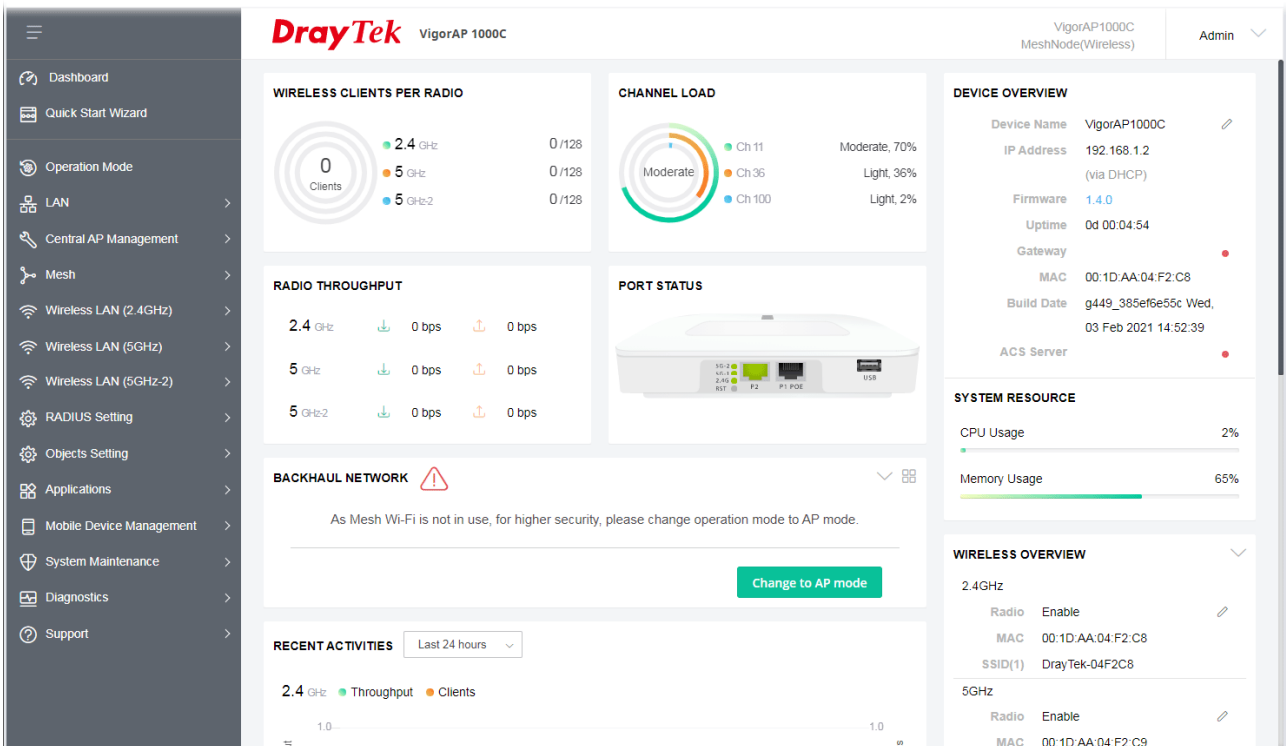

- The web page can be logged out by clicking **Log Out** on the top right of the web page. Or, logout the web user interface according to the chosen condition. The default setting is **Auto Logout**, which means the web configuration system will logout after 5 minutes without any operation. Change the setting of auto logout if you want.

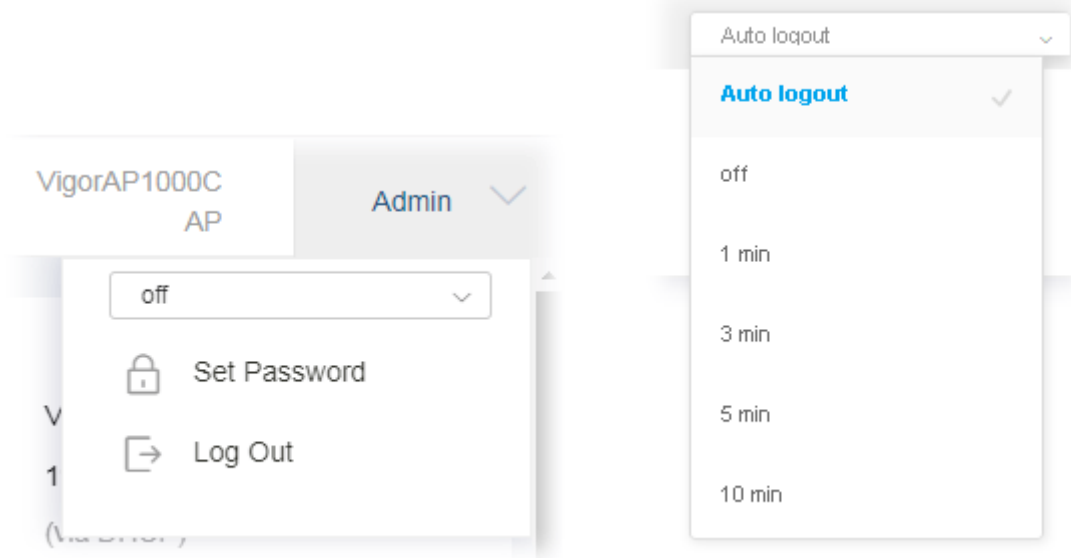

---

**i** Note:

If you fail to access the web configuration, please go to the section “Trouble Shooting” for detecting and solving your problem.

For using the device properly, it is necessary for you to change the password of web configuration for security and adjust primary basic settings.

---

# I-5 Changing Password

1. Please change the password for the original security of the modem.
2. Go to **System Maintenance** page and choose **Administration Password**.

System Maintenance >> Administration Password

## Administrator Settings

Account	<input type="text" value="admin"/>
Old Password	<input type="password" value="....."/>
New Password	<input type="password" value="....."/>
Confirm Password	<input type="password" value="....."/>
Password Strength:	<span>Weak</span> <span>Medium</span> <span>Strong</span>

Strong password requirements:  
1. Have at least one upper-case letter and one lower-case letter.  
2. Including non-alphanumeric characters is a plus.

**Note :** Authorization Account can contain only a-z A-Z 0-9 , ~ ` ! @ \$ % ^ \* ( ) \_ - + = { } [ ] | ; < > . ?  
Authorization Password can contain only a-z A-Z 0-9 , ~ ` ! @ # \$ % ^ & \* ( ) \_ - + = { } [ ] \ ; < > . ? /

3. Enter the new login password on the field of **Password**. Then click **OK** to continue.
4. Now, the password has been changed. Next time, use the new password to access the Web User Interface for this modem.

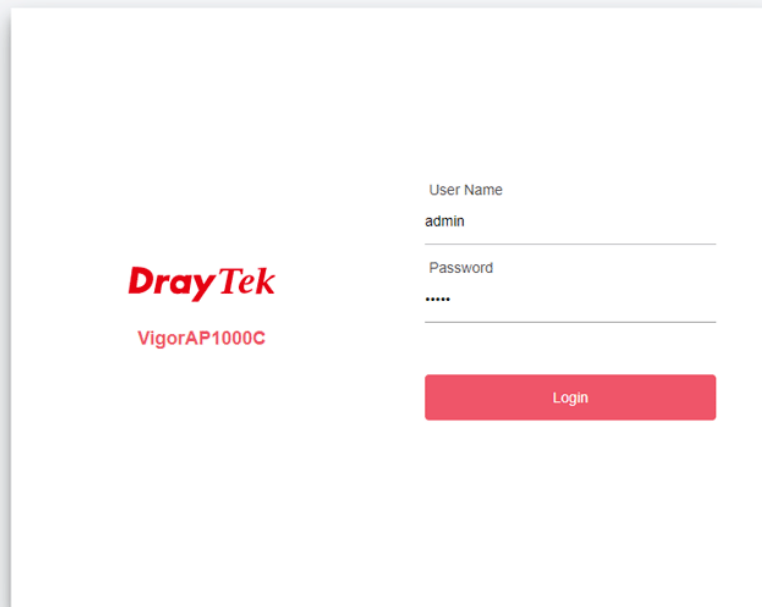

The image shows the login page for a DrayTek VigorAP1000C modem. On the left, the DrayTek logo and model name are displayed. On the right, there are two input fields: 'User Name' with 'admin' entered and 'Password' with '.....' entered. Below the fields is a red 'Login' button.

Copyright © 2018 DrayTek Corp

# I-6 Dashboard

Dashboard shows system status including the number of client connected, throughput, gateway, physical connection status, radio (2.4GHz / 5GHz / 5GHz-2) status, backhaul network, recent activities, wireless network usage, and so on.

Click **Dashboard** from the main menu on the left side of the main page.

The screenshot displays the DrayTek VigorAP 1000C dashboard. The interface includes a left-hand navigation menu with options like Dashboard, Quick Start Wizard, Operation Mode, LAN, Central AP Management, Mesh, Wireless LAN (2.4GHz), Wireless LAN (5GHz), Wireless LAN (5GHz-2), RADIUS Setting, Objects Setting, Applications, Mobile Device Management, System Maintenance, Diagnostics, and Support. The main content area is divided into several sections:

- WIRELESS CLIENTS PER RADIO:** Shows 0 clients connected across three radio bands: 2.4 GHz (0/128), 5 GHz (0/128), and 5 GHz-2 (0/128).
- CHANNEL LOAD:** A gauge chart showing channel utilization: Ch 11 (Moderate, 70%), Ch 36 (Light, 36%), and Ch 100 (Light, 2%).
- RADIO THROUGHPUT:** Displays throughput for 2.4 GHz, 5 GHz, and 5 GHz-2, all showing 0 bps for both download and upload.
- PORT STATUS:** Includes an image of the device and a table of port statuses: 10/100, 4/10/25, 2/10/25, RST, F2, P1 POE, and USB.
- DEVICE OVERVIEW:** Provides key device information: Device Name (VigorAP1000C), IP Address (192.168.1.2), Firmware (1.4.0), Uptime (0d 00:04:54), Gateway, MAC (00:1D:AA:04:F2:C8), Build Date (03 Feb 2021 14:52:39), and ACS Server status.
- SYSTEM RESOURCE:** Shows CPU Usage at 2% and Memory Usage at 65%.
- WIRELESS OVERVIEW:** Lists the status of 2.4GHz and 5GHz radios (both Enabled) and their associated MAC addresses.
- BACKHAUL NETWORK:** Displays a warning icon and the message: "As Mesh Wi-Fi is not in use, for higher security, please change operation mode to AP mode." with a "Change to AP mode" button.
- RECENT ACTIVITIES:** A chart showing throughput and client activity for the last 24 hours, with a scale from 0 to 1.0.

# I-7 Quick Start Wizard

Quick Start Wizard will guide you to configure 2.4G /5G/5G-2 wireless setting and other corresponding settings for Vigor Access Point step by step.

**Quick Start Wizard**



Device  
VigorAP1000C  
MAC  
00:1D:AA:04:F2:C8  
Firmware  
1.4.0  
Operation Mode  
Mesh Node

1 Operation Mode    2 WiFi Setup    3 Admin Password    4 Finish

Operation Mode  (Suggested when having wired uplink)

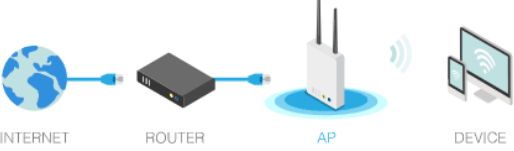

INTERNET    ROUTER    AP    DEVICE

Available operation mode includes:

- Access Point
- Mesh Root
- Mesh Node
- Range Extender

In this page, the advanced settings pages will vary according to the operation mode specified.



## I-7-1 Settings for Access Point

1. Choose **Access Point** as the operation mode and click **Next Step**.

**Quick Start Wizard**



Device  
VigorAP1000C  
MAC  
00:1D:AA:04:F2:C8  
Firmware  
1.4.0  
Operation Mode  
Mesh Node

1 Operation Mode   2 WiFi Setup   3 Admin Password   4 Finish

Operation Mode: Access Point (Suggested when having wired uplink)

- Access Point ✓
- Mesh Root
- Mesh Node
- Range Extender

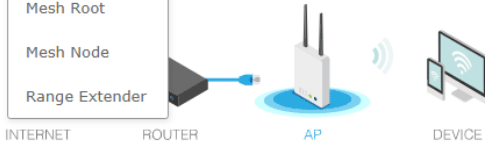

INTERNET   ROUTER   AP   DEVICE

Cancel   Next Step >

2. In the following page, configure the settings for wireless LAN (for 2.4GHz, 5GHz and 5GHz-2) and click **Next Step**.

**Quick Start Wizard**



Device  
VigorAP1000C  
MAC  
00:1D:AA:04:F2:C8  
Firmware  
1.4.0  
Operation Mode  
Mesh Node

1 Operation Mode   2 WiFi Setup   3 Admin Password   4 Finish

Your AP is under default config. Please setup first.

WiFi Name: DrayTek-04F2C8  
WiFi Password: .....

Enable 2nd WiFi

2nd WiFi Name: \_\_\_\_\_  
2nd WiFi Password: .....

Enable Bandwidth Limit  
 Enable Station Control

**Note:** The WiFi settings will apply to all Wireless bands.

< Back   Cancel   Next Step >

Available settings are explained as follows:

Item	Description
<b>WiFi Name</b>	Set a name for VigorAP 1000C to be identified.
<b>WiFi Password</b>	Type <b>8~63</b> ASCII characters, such as 012345678..(or <b>64</b> Hexadecimal digits leading by 0x, such as "0x321253abcde...").
<b>Enable 2nd Wireless</b>	<p>Check the box to enable the <b>guest</b> wireless setting.</p> <p>Such feature is especially useful for free Wi-Fi service. For example, a coffee shop offers free Wi-Fi service for its guests for one hour every day.</p> <p><b>2nd WiFi Name</b> - Set a name for VigorAP device which can be identified and connected by wireless guest.</p> <p><b>2nd WiFi Password</b> - Set <b>8~63</b> ASCII characters or <b>64</b> Hexadecimal digits leading by 0x which can be used for logging into VigorAP device by wireless guest.</p>
<b>Enable Bandwidth Limit</b>	<p>Check the box to define the maximum speed of the data uploading/downloading which will be used for the guest connecting to Vigor device with the same SSID.</p> <p><b>Upload Limit</b> - Scroll the radio button to choose the value you want.</p> <p><b>Download Limit</b> -Scroll the radio button to choose the value you want.</p>
<b>Enable Station Control</b>	<p>Check the box to set the duration for the guest connecting /reconnecting to Vigor device.</p> <p><b>Connection Time</b> -Scroll the radio button to choose the value you want.</p> <p><b>Reconnection Time</b> -Scroll the radio button to choose the value you want.</p>

3. Change the default password for such device with new value. Then click **Next Step**.

### Quick Start Wizard



1 — 2 — 3 — 4

Operation Mode   WiFi Setup   Admin Password   Finish

Your AP is under default config. Please setup first.

Admin Password:

Confirm Password:

Device  
VigorAP1000C

MAC  
00:1D:AA:04:F2:C8

Firmware  
1.4.0

Operation Mode  
Mesh Node

< Back
Cancel Next Step >

Available settings are explained as follows:

Item	Description
<b>Admin Password</b>	Enter a new password.
<b>Confirm Password</b>	Enter the new password again for confirmation.

4. A summary of settings configuration will be shown on screen. Click **Finish**.

### Quick Start Wizard



1 — 2 — 3 — 4  
Operation Mode — WiFi Setup — Admin Password — Finish

Basic settings are completed. Press Finish button apply changes.

Operation Mode	Pure AP
WiFi Name	DrayTek-04F2C8
2nd WiFi Name	Disabled
Bandwidth Limit	Disabled
Station Control	Disabled

Device  
VigorAP1000C

MAC  
00:1D:AA:04:F2:C8

Firmware  
1.4.0

Operation Mode  
Mesh Node

< Back

Cancel Finish

## I-7-2 Settings for Mesh Root

1. Choose **Mesh Root** as the operation mode and click **Next Step**.

**Quick Start Wizard**



Device  
VigorAP1000C  
MAC  
00:1D:AA:04:F2:C8  
Firmware  
1.4.0  
Operation Mode  
Mesh Node

1 Operation Mode    2 WiFi Setup    3 Admin Password    4 Finish

Operation Mode: Mesh Root  
Group Name: VigorMesh

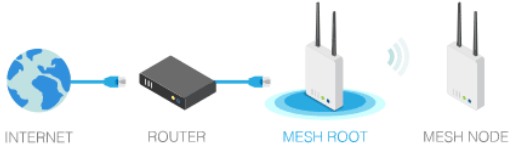

INTERNET    ROUTER    MESH ROOT    MESH NODE

Disable Wizard    Cancel    Next Step >

2. Configure the settings for wireless LAN (for 2.4GHz, 5GHz and 5GHz-2) and click **Next Step**.

**Quick Start Wizard**



Device  
VigorAP1000C  
MAC  
00:1D:AA:04:F2:C8  
Firmware  
1.4.0  
Operation Mode  
Mesh Node

1 Operation Mode    2 WiFi Setup    3 Admin Password    4 Finish

Your AP is under default config. Please setup first.

WiFi Name: DrayTek-04F2C8  
WiFi Password: .....

Enable 2nd WiFi  
2nd WiFi Name: .....  
2nd WiFi Password: .....

Enable Bandwidth Limit  
 Enable Station Control

**Note:** The WiFi settings will apply to all Wireless bands.

< Back    Cancel    Next Step >

Available settings are explained as follows:

<b>Item</b>	<b>Description</b>
<b>WiFi Name</b>	Set a name for VigorAP 1000C to be identified.
<b>WiFi Password</b>	Type <b>8~63</b> ASCII characters, such as 012345678..(or <b>64</b> Hexadecimal digits leading by 0x, such as "0x321253abcde...").
<b>Enable 2nd WiFi</b>	<p>Check the box to enable the second wireless setting.</p> <p>Such feature is especially useful for free Wi-Fi service. For example, a coffee shop offers free Wi-Fi service for its guests for one hour every day.</p> <p><b>2nd WiFi Name</b> - Set a name for VigorAP 1000C which can be identified and connected by wireless guest.</p> <p><b>2nd WiFi Password</b> - Set <b>8~63</b> ASCII characters or <b>64</b> Hexadecimal digits leading by 0x which can be used for logging into VigorAP 1000C by wireless guest.</p>
<b>Enable Bandwidth Limit</b>	<p>Check the box to define the maximum speed of the data uploading/downloading which will be used for the guest connecting to Vigor device with the same SSID.</p> <p><b>Upload Limit</b> - Scroll the radio button to choose the value you want.</p> <p><b>Download Limit</b> -Scroll the radio button to choose the value you want.</p>
<b>Enable Station Control</b>	<p>Check the box to set the duration for the guest connecting /reconnecting to Vigor device.</p> <p><b>Connection Time</b> -Scroll the radio button to choose the value you want.</p> <p><b>Reconnection Time</b> -Scroll the radio button to choose the value you want.</p>

- Change the default password for such device with new value. Then click **Next Step**.

**Quick Start Wizard**



1 — 2 — 3 — 4  
 Operation Mode — WiFi Setup — Admin Password — Finish

Your AP is under default config. Please setup first.

Admin Password:

Confirm Password:

Device  
 VigorAP1000C  
 MAC  
 00:1D:AA:04:F2:C8  
 Firmware  
 1.4.0  
 Operation Mode  
 Mesh Node

< Back Cancel **Next Step** >

Available settings are explained as follows:

Item	Description
<b>Admin Password</b>	Enter a new password.
<b>Confirm Password</b>	Enter the new password again for confirmation.

- A summary of settings configuration will be shown on screen. Click **Finish**.

**Quick Start Wizard**



1 — 2 — 3 — 4  
 Operation Mode — WiFi Setup — Admin Password — Finish

Basic settings are completed. Press Finish button apply changes.

Operation Mode	Mesh Root
WiFi Name	DrayTek-04F2C8
2nd WiFi Name	Disabled
Bandwidth Limit	Disabled
Station Control	Disabled

Device  
 VigorAP1000C  
 MAC  
 00:1D:AA:04:F2:C8  
 Firmware  
 1.4.0  
 Operation Mode  
 Mesh Node

< Back Cancel **Finish**

5. After clicking **Finish**, the following web page appears. VigorAP will search for mesh node around the network.

1 Restart Wireless 2 Mesh Node Setup 3 Finish

Please wait for wireless restart.

### Quick Start Wizard

1 Restart Wireless 2 Mesh Node Setup 3 Finish

Setup additional VigorAPs to Mesh network?

Please power up and wait for us to find it.

Device  
VigorAP1000C  
MAC  
00:1D:AA:04:F2:C8  
Firmware  
1.4.0  
Operation Mode  
Mesh Root

Sending settings to mesh node Search

< Back Cancel Apply

- Available VigorAP devices will be shown on the screen. Select the device (as a mesh node) for grouping under such mesh group and enter a device name for identification.

### Quick Start Wizard



1

Restart Wireless

2

Mesh Node Setup

3

Finish

Setup additional VigorAPs to Mesh network?

Please power up and wait for us to find it.

Select	Model	MAC	Device Name
<input checked="" type="checkbox"/>	VigorAP903	00:50:7F:F1:7E:EA	<input type="text" value="room"/>
<input type="checkbox"/>	VigorAP920R	00:1D:AA:5C:A6:C8	<input type="text"/>
<input type="checkbox"/>	VigorAP802	00:1D:AA:22:83:88	<input type="text"/>
<input type="checkbox"/>	VigorAP920R	00:1D:AA:68:D6:80	<input type="text"/>

Sending settings to mesh node Search

< Back
Cancel Apply

Device  
**VigorAP1000C**

MAC  
**00:1D:AA:04:F2:C8**

Firmware  
**1.4.0**

Operation Mode  
**Mesh Root**

- Click **Apply** and wait for a while.



1

Restart Wireless

2

Mesh Node Setup

3

Finish

Setup additional VigorAPs to Mesh network?

Please power up and wait for us to find it.

Select	Model	MAC	Device Name
<input checked="" type="checkbox"/>	VigorAP903	00:50:7F:F1:7E:EA	<input type="text" value="room"/>
<input type="checkbox"/>	VigorAP920R	00:1D:AA:5C:A6:C8	<input type="text"/>
<input type="checkbox"/>	VigorAP802	00:1D:AA:22:83:88	<input type="text"/>
<input type="checkbox"/>	VigorAP920R	00:1D:AA:68:D6:80	<input type="text"/>

Sending settings to mesh node

< Back
Cancel Apply

Device  
**VigorAP1000C**

MAC  
**00:1D:AA:04:F2:C8**

Firmware  
**1.4.0**

Operation Mode  
**Mesh Root**





8. Later, a summary page of mesh root with mesh node will be shown on the screen.



1 Restart Wireless    2 Mesh Node Setup    3 Finish

Setup 1 Mesh Root and 1 Mesh Node completed.

ROOT		VigorAP1000C VigorAP1000C	1 Node	0 Offline
		room VigorAP903	-0dbm	00:50:7F:F1:7E:EA

Device  
VigorAP1000C  
MAC  
00:1D:AA:04:F2:C8  
Firmware  
1.4.0  
Operation Mode  
Mesh Root

< Back    Cancel    Finish

## I-7-3 Settings for Mesh Node

1. Choose **Mesh Node** as the operation mode and click **Next Step**.

**Quick Start Wizard**

Device  
VigorAP1000C  
MAC  
00:1D:AA:04:F2:C8  
Firmware  
1.4.0  
Operation Mode  
Mesh Root

Operation Mode: Mesh Node

INTERNET ROUTER MESH ROOT MESH NODE DEVICE

Cancel Next Step >

2. A summary of settings configuration will be shown on screen. Click **Finish**.

**Quick Start Wizard**

Device  
VigorAP1000C  
MAC  
00:1D:AA:04:F2:C8  
Firmware  
1.4.0  
Operation Mode  
Mesh Root

Finish Setup this AP as Mesh Node.  
Please use Mesh Root or Mobile APP to search this device and let it join one Mesh Group.

< Back Cancel Finish

## I-7-4 Settings for Range Extender

1. Choose **Range Extender** as the operation mode and click **Next Step**.

**Quick Start Wizard**



Device  
VigorAP1000C  
MAC  
00:1D:AA:04:F2:C8  
Firmware  
1.4.0  
Operation Mode  
Mesh Root

1 Operation Mode   2 WiFi Setup   3 Admin Password   4 Finish

Operation Mode: Range Extender



AP   RANGE EXTENDER   DEVICE

Disable Wizard   Cancel   Next Step >

2. Configure the settings for wireless LAN (for 2.4GHz, 5GHz and 5GHz-2) and click **Next Step**.

**Quick Start Wizard**



Device  
VigorAP1000C  
MAC  
00:1D:AA:04:F2:C8  
Firmware  
1.4.0  
Operation Mode  
Mesh Root

1 Operation Mode   2 WiFi Setup   3 Admin Password   4 Range Extender   5 Finish

Your AP is under default config. Please setup first.

WiFi Name: DrayTek-04F2C8  
WiFi Password: .....

Enable 2nd WiFi  
2nd WiFi Name: .....  
2nd WiFi Password: .....

Enable Bandwidth Limit  
 Enable Station Control

**Note:** The WiFi settings will apply to all Wireless bands.

< Back   Cancel   Next Step >

Available settings are explained as follows:

Item	Description
<b>WiFi Name</b>	Set a name for VigorAP 1000C to be identified.
<b>WiFi Password</b>	Type <b>8~63</b> ASCII characters, such as 012345678..(or <b>64</b> Hexadecimal digits leading by 0x, such as "0x321253abcde...").
<b>Enable 2nd WiFi</b>	<p>Check the box to enable the second wireless setting.</p> <p>Such feature is especially useful for free Wi-Fi service. For example, a coffee shop offers free Wi-Fi service for its guests for one hour every day.</p> <p><b>2nd WiFi Name</b> - Set a name for VigorAP 1000C which can be identified and connected by wireless guest.</p> <p><b>2nd WiFi Password</b> - Set <b>8~63</b> ASCII characters or <b>64</b> Hexadecimal digits leading by 0x which can be used for logging into VigorAP 1000C by wireless guest.</p>
<b>Enable Bandwidth Limit</b>	<p>Check the box to define the maximum speed of the data uploading/downloading which will be used for the guest connecting to Vigor device with the same SSID.</p> <p><b>Upload Limit</b> - Scroll the radio button to choose the value you want.</p> <p><b>Download Limit</b> -Scroll the radio button to choose the value you want.</p>
<b>Enable Station Control</b>	<p>Check the box to set the duration for the guest connecting /reconnecting to Vigor device.</p> <p><b>Connection Time</b> -Scroll the radio button to choose the value you want.</p> <p><b>Reconnection Time</b> -Scroll the radio button to choose the value you want.</p>

- Change the default password for such device with new value. Then click **Next Step**.

### Quick Start Wizard



1  
 Operation Mode

2  
 WiFi Setup

3  
 Admin Password

4  
 Range Extender

5  
 Finish

Your AP is under default config. Please setup first.

Admin Password:

Confirm Password:

Device  
VigorAP1000C

MAC  
00:1D:AA:04:F2:C8

Firmware  
1.4.0

Operation Mode  
Mesh Root

[< Back](#)

[Cancel](#) [Next Step >](#)

Available settings are explained as follows:

Item	Description
<b>Admin Password</b>	Enter a new password.
<b>Confirm Password</b>	Enter the new password again for confirmation.

- In the following page, click **Search** to find out neighboring access point. When all the available access points appear on the page, click the one you want to connect. Corresponding settings (e.g., SSID, Security Mode) of the selected device will be shown below. Enter the Security Key. Then click **Next Step**.



1  
 Operation Mode

2  
 WiFi Setup

3  
 Admin Password

4  
 Range Extender

5  
 Finish

2.4GHz WLAN
  5GHz WLAN
  5GHz-2 WLAN

SSID	BSSID	RSSI	Channel	Encryption	Authentication
<input type="radio"/> FAE-Wendy-2925-...	00:1D:AA:F0:6D:F0	56%(-75dbm)	11	AES	WPA2/PSK
<input type="radio"/> FAE2925_Guest	02:1D:AA:F0:6D:F0	59%(-74dbm)	11	AES	WPA2
<input type="radio"/> DrayTek-3F4F4C	00:1D:AA:3F:4F:4C	76%(-69dbm)	11	AES	WPA2/PSK
<input type="radio"/> DrayTekF19216	02:50:7F:C1:92:16	95%(-59dbm)	11	TKIP/AES	Mixed(WPA+WPA2)/PSK
<input type="radio"/> 918PQC_helen	00:1D:AA:04:F0:60	94%(-60dbm)	11	TKIP/AES	Mixed(WPA+WPA2)/PSK
<input type="radio"/> DrayTek-3F4FOA	00:1D:AA:3F:4F:0A	84%(-67dbm)	11	AES	WPA2/PSK
<input type="radio"/> Vigor2927 PQC T...	16:49:BC:42:37:D8	92%(-63dbm)	11	AES	WPA2/PSK
<input checked="" type="radio"/> guests	06:1D:AA:3F:4F:86	98%(-54dbm)	1	AES	WPA2/PSK
<input type="radio"/> staffs	02:50:7F:47:29:0C	28%(-83dbm)	1	AES	WPA2/PSK
<input type="radio"/>	12:1D:AA:04:F0:D8	73%(-70dbm)	1	AES	WPA2/PSK
<input type="radio"/> guests	02:50:7F:57:29:0C	32%(-82dbm)	1	AES	WPA2/PSK
<input type="radio"/> staffs	00:1D:AA:63:2C:10	100%(-42dbm)	1	AES	WPA2/PSK
<input type="radio"/>	12:1D:AA:3F:4F:86	100%(-53dbm)	1	AES	WPA2/PSK

Device  
VigorAP1000C

MAC  
00:1D:AA:04:F2:C8

Firmware  
1.4.0

Operation Mode  
Mesh Root

[< Back](#)

SSID:

Channel:

Security Mode:

Encryption Type:

Security Key:

[Cancel](#) [Next Step >](#)

Available settings are explained as follows:

Item	Description
<b>SSID</b>	Displays the SSID of the selected access point.
<b>Channel</b>	Means the channel frequency of the wireless LAN. You may switch channel if the selected channel is under serious interference.
<b>Security Mode</b>	There are several modes provided for you to choose. Each mode will bring up different parameters (e.g., WEP keys, Pass Phrase) for you to configure.
<b>Encryption Type</b>	<p>Available options will vary according to the selected <b>Security Mode</b>.</p> <p><b>When Open is selected:</b></p> <ul style="list-style-type: none"> <li>● Choose <b>None</b> to disable the WEP Encryption. Data sent to the AP will not be encrypted.</li> <li>● <b>WEP Keys</b> -To enable WEP encryption for data transmission, please choose <b>WEP</b>. Four keys can be entered here, but only one key can be selected at a time. The format of WEP Key is restricted to 5 ASCII characters or 10 hexadecimal values in 64-bit encryption level, or restricted to 13 ASCII characters or 26 hexadecimal values in 128-bit encryption level. The allowed content is the ASCII characters from 33(!) to 126(~) except '#' and '':.</li> </ul> <p><b>When Shared is selected:</b></p> <ul style="list-style-type: none"> <li>● <b>WEP Keys</b> - To enable WEP encryption for data transmission, please choose <b>WEP</b>. Four keys can be entered here, but only one key can be selected at a time. The format of WEP Key is restricted to 5 ASCII characters or 10 hexadecimal values in 64-bit encryption level, or restricted to 13 ASCII characters or 26 hexadecimal values in 128-bit encryption level. The allowed content is the ASCII characters from 33(!) to 126(~) except '#' and '':.</li> </ul> <p><b>When WPA/PSK or WPA2/PSK is selected:</b></p> <ul style="list-style-type: none"> <li>● Select <b>TKIP</b> or <b>AES</b> as the algorithm for WPA.  <b>Security Key</b> - Enter <b>8~63</b> ASCII characters, such as 012345678..(or 64 Hexadecimal digits leading by 0x, such as "0x321253abcde...").</li> </ul>

5. A summary of settings configuration will be shown on screen. Click **Finish**.

### Quick Start Wizard



1 Operation Mode   2 WiFi Setup   3 Admin Password   4 Range Extender   5 Finish

Basic settings are completed. Press Finish button apply changes.

Operation Mode	Range Extender (2.4GHz WLAN)
Peer SSID	123456789
WiFi Name	DrayTek-04F2C8
2nd WiFi Name	Disabled
Bandwidth Limit	Disabled
Station Control	Disabled

Device  
VigorAP1000C

MAC  
00:1D:AA:04:F2:C8

Firmware  
1.4.0

Operation Mode  
Mesh Root

< Back

Cancel Finish

This page is left blank.



# Chapter II Connectivity

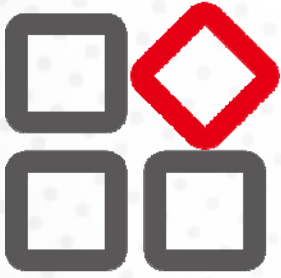

# II-1 Operation Mode

This page provides several available modes for you to choose for different conditions. Click any one of them and click **OK**. The system will configure the required settings automatically.

## Operation Mode Configuration

**AP :**

VigorAP acts as a bridge between wireless devices and wired Ethernet network, and exchanges data between them.

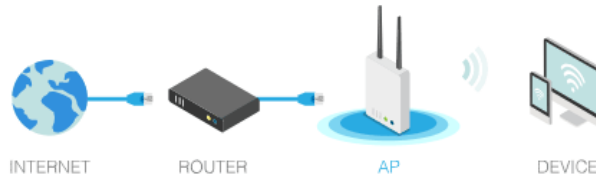

**Mesh :**

**Mesh Root:**

AP connects to gateway with Ethernet cable. It would be other AP's uplink connection.

**Mesh Node:**

Use wireless to connect to other Mesh Root when Ethernet cable doesn't exist. A mesh network creates a set of links automatically and calculate the most optimal wireless path through the wireless network back to a wired Mesh Root.

**Range Extender :**

VigorAP can act as a wireless repeater; it can be Station and AP at the same time.

OK

Available settings are explained as follows:

Item	Description
<b>AP</b>	This mode allows wireless clients to connect to access point and exchange data with the devices connected to the wired network.
<b>Mesh</b>	<p><b>Mesh Root</b> – VigorAP must connect to a gateway with an Ethernet cable.</p> <p><b>Mesh Node</b> – VigorAP can connect to other mesh root via wireless connection. A mesh network creates one set of links automatically and calculates the most optimal wireless path through the wireless network back to a wired mesh root.</p>
<b>Range Extender</b>	VigorAP can act as a wireless repeater which will help you to extend the networking wirelessly. The access point can act as Station and AP at the same time. It can use Station function to connect to a Root AP and use AP function to service all wireless clients within its coverage.

---

 Note:

The Wireless LAN settings will be changed according to the Operation Mode selected here. For the detailed information, please refer to the section of Wireless LAN.

---

## II-2 General Concepts for Wireless LAN

---

VigorAP 1000C is a highly integrated wireless local area network (WLAN) for 5 GHz 802.11ac or 2.4/5 GHz 802.11n WLAN applications. It supports channel operations of 20/40 MHz at 2.4 GHz and 20/40/80 MHz at 5 GHz. VigorAP 1000C can support data rates up to 867 MBps in 802.11ac 80 MHz channels.

---

### Note:

\* The actual data throughput will vary according to the network conditions and environmental factors, including volume of network traffic, network overhead and building materials.

---

VigorAP 1000C plays a role as an Access Point (AP) connecting to lots of wireless clients or Stations (STA). All the STAs will share the same Internet connection via VigorAP 1000C. The **General Setup** will set up the information of this wireless network, including its SSID as identification, located channel etc.

### **Security Overview**

WEP (Wired Equivalent Privacy) is a legacy method to encrypt each frame transmitted via radio using either a 64-bit or 128-bit key. Usually access point will preset a set of four keys and it will communicate with each station using only one out of the four keys.

WPA (Wi-Fi Protected Access), the most dominating security mechanism in industry, is separated into two categories: WPA-personal or called WPA Pre-Share Key (WPA/PSK), and WPA-Enterprise or called WPA/802.1x.

In WPA-Personal, a pre-defined key is used for encryption during data transmission. WPA applies Temporal Key Integrity Protocol (TKIP) for data encryption while WPA2 applies AES. The WPA-Enterprise combines not only encryption but also authentication.

Since WEP has been proved vulnerable, you may consider using WPA for the most secure connection. You should select the appropriate security mechanism according to your needs. No matter which security suite you select, they all will enhance the over-the-air data protection and /or privacy on your wireless network. The VigorAP 1000C is very flexible and can support multiple secure connections with both WEP and WPA at the same time.

### **WPS Introduction**

**WPS (Wi-Fi Protected Setup)** provides easy procedure to make network connection between wireless station and wireless access point (VigorAP 1000C) with the encryption of WPA and WPA2.



It is the simplest way to build connection between wireless network clients and VigorAP 1000C. Users do not need to select any encryption mode and type any long encryption passphrase to setup a wireless client every time. He/she only needs to press a button on wireless client, and WPS will connect for client and VigorAP 1000C automatically.

**i** Note:

Such function is available for the wireless station with WPS supported.

There are two methods to do network connection through WPS between AP and Stations: pressing the **Start PBC** button or using **PIN Code**.

On the side of VigorAP 1000C series which served as an AP, press **WPS** button once on the front panel of VigorAP 1000C or click **Start PBC** on web configuration interface. On the side of a station with network card installed, press **Start PBC** button of network card.

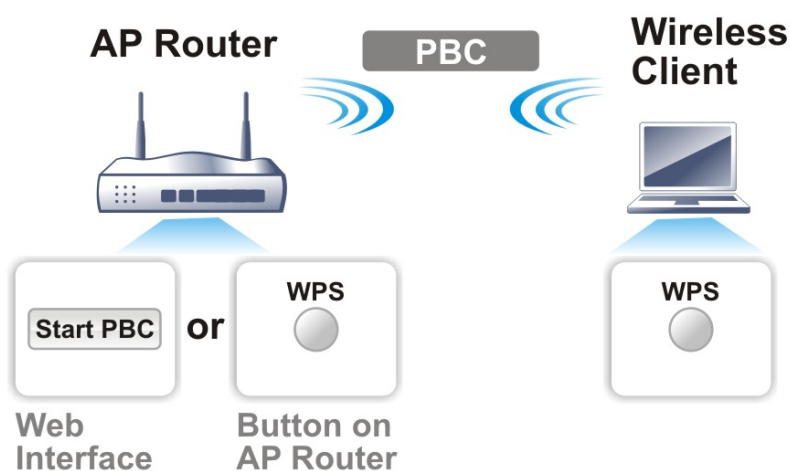

If you want to use PIN code, you have to know the PIN code specified in wireless client. Then provide the PIN code of the wireless client you wish to connect to the VigorAP 1000C.

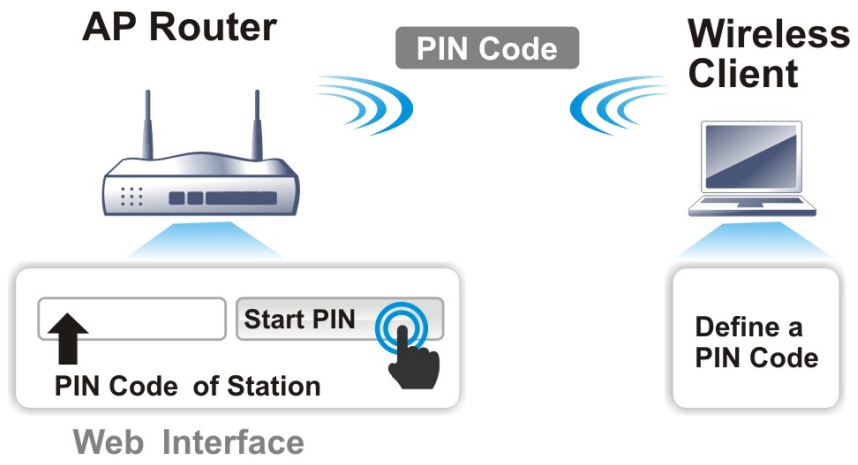

## II-3 Wireless LAN (2.4GHz/5GHz/5GHz-2) Settings for AP Mode

---

VigorAP 1000C is a tri-band, including 2.4GHz/5GHz/5GHz-2, access point. In which, the band of 5GHz-2 can deliver double bandwidths over 5GHz to offer more stable wireless performance.

When you choose **AP** as the operation mode, the Wireless LAN menu items will include General Setup, Security, Access Control, WPS, Advanced Setting, AP Discovery, WDS AP Status, Bandwidth Management, Airtime Fairness, Station Control, Roaming, Band Steering (for 2.4GHz) and Station List.

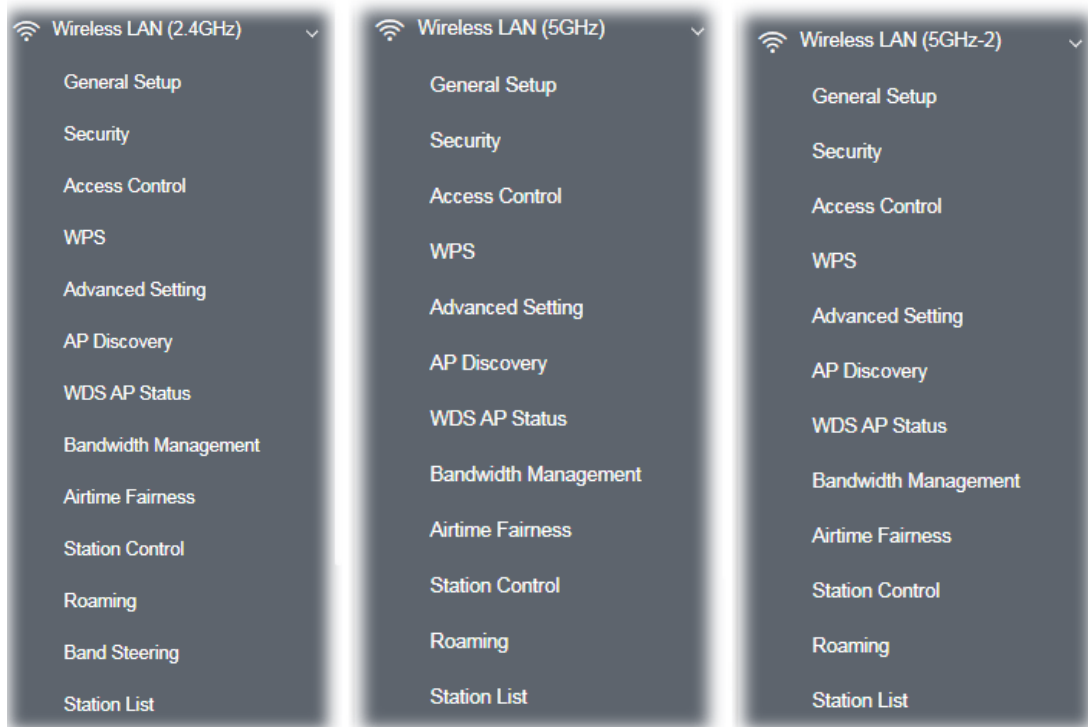

### Note:

Available settings for **Wireless LAN (2.4GHz)**, **Wireless LAN (5GHz)** and **Wireless LAN (5GHz-2)** are almost the same, except for Band Steering.

The following figure shows how VigorAP runs as **AP** (Access Point)

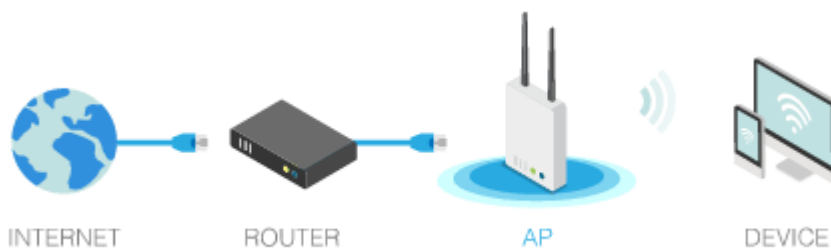

## II-3-1 General Setup

By clicking the **General Setup**, a new web page will appear so that you could select mode, channel, the SSID, the wireless channel, 2nd subnet and WDS. Please refer to the following figure for more information.

Wireless LAN (2.4GHz) >> General Setup

---

General Setting ( IEEE 802.11 )

Enable Wireless LAN

Enable Client Limit  (3 ~ 128, default: 128)

Enable Client Limit per SSID (3 ~ 128, default: 128)

---

Mode :

Channel :

Extension Channel :

---

Enable 2 Subnet (Simulate 2 APs)

Enable Bridge VLAN to Mesh

	Enable	Hide SSID	SSID	Subnet	Isolate LAN	Isolate Member(0:Untagged)	VLAN ID
1	<input type="checkbox"/>	<input type="checkbox"/>	<input type="text" value="DrayTek-04F2C8"/>	<input type="text" value="LAN-A"/>	<input type="checkbox"/>	<input type="checkbox"/>	<input type="text" value="0"/>
2	<input checked="" type="checkbox"/>	<input type="checkbox"/>	<input type="text" value="marketing"/>	<input type="text" value="LAN-A"/>	<input type="checkbox"/>	<input type="checkbox"/>	<input type="text" value="0"/>
3	<input type="checkbox"/>	<input type="checkbox"/>	<input type="text"/>	<input type="text" value="LAN-A"/>	<input type="checkbox"/>	<input type="checkbox"/>	<input type="text" value="0"/>
4	<input type="checkbox"/>	<input type="checkbox"/>	<input type="text"/>	<input type="text" value="LAN-A"/>	<input type="checkbox"/>	<input type="checkbox"/>	<input type="text" value="0"/>

Hide SSID: Prevent SSID from being scanned.  
 Isolate LAN: Wireless clients (stations) with the same SSID cannot access wired PCs on LAN.  
 Isolate Member: Wireless clients (stations) with the same SSID cannot access for each other.  
 Isolate Exception: Isolate Exception can be created by adding the MAC from [Device Object](#).

---

WDS Settings (PHY Mode : HTMIX)

<p>Security :</p> <p><input checked="" type="radio"/> Disabled <input type="radio"/> TKIP <input type="radio"/> AES</p> <p>Key :</p> <input type="text"/>	<p>Peer MAC Address :</p> <p>1. <input type="text"/> : <input type="text"/> : <input type="text"/> : <input type="text"/> : <input type="text"/> : <input type="text"/></p> <p>2. <input type="text"/> : <input type="text"/> : <input type="text"/> : <input type="text"/> : <input type="text"/> : <input type="text"/></p> <p>3. <input type="text"/> : <input type="text"/> : <input type="text"/> : <input type="text"/> : <input type="text"/> : <input type="text"/></p> <p>4. <input type="text"/> : <input type="text"/> : <input type="text"/> : <input type="text"/> : <input type="text"/> : <input type="text"/></p>
---	---

Note: Enter the configuration of APs which AP1000C want to connect.  
 Remote AP should always use LAN-A or SSID1 MAC address to connect AP1000C WDS.

Available settings are explained as follows:

Item	Description
<b>Enable Wireless LAN</b>	Check the box to enable wireless function.
<b>Enable Client Limit</b>	Check the box to set the maximum number of wireless stations which try to connect Internet through Vigor device. The number you can set is from 3 to 64.
<b>Enable Client Limit per</b>	Define the maximum number of wireless stations per SSID which try to connect to Internet through Vigor device. The number you can set



<b>SSID</b>	is from 3 to 64.
<b>Mode</b>	<p>At present, VigorAP 1000C can connect to 11a only, 11n only, Mixed (11a+11n), and Mixed (11a+11n+11ac) stations simultaneously. Simply choose Mixed (11a+11n+11ac) mode.</p>  <p>(for 2.4GHz)</p> <p>(for 5GHz / 5GHz-2)</p>
<b>Channel</b>	<p>Means the channel of frequency of the wireless LAN.</p> <p>As a tri-band access point, VigorAP offers different channels for WLAN 2.4GHz, 5GHZ and 5GHz-2 respectively.</p> <p>You may switch channel if the selected channel is under serious interference. If you have no idea of choosing the frequency, please select <b>AutoSelect</b> to let system determine for you.</p> <p><b>Filtered Out List</b> - It will be shown if <b>AutoSelect</b> is selected as <b>Channel</b>. Click such link to access into <b>Wireless LAN &gt;&gt; Advanced Settings</b> page.</p>
<b>Extension Channel (for 2.4GHz)</b>	With 802.11n, there is one option to double the bandwidth per channel. The available extension channel options will be varied according to the <b>Channel</b> selected above. Configure the extension channel you want.
<b>Enable 2 Subnet (Simulate 2 APs)</b>	<p>Check the box to enable the function for two independent subnets. Once you enable this function, LAN-A and LAN-B would be independent. Next, you can connect one router in LAN-A, and another router in LAN-B. Such mechanism can make you feeling that you have two independent AP/subnet functions in one VigorAP 1000C.</p> <p>If you disable this function, LAN-A and LAN-B ports are in the same domain. You could only connect one router (no matter connecting to LAN-A or LAN-B) in this environment.</p>
<b>Enable</b>	Check it to enable the SSID setting.
<b>Hide SSID</b>	Check it to prevent from wireless sniffing and make it harder for unauthorized clients or STAs to join your wireless LAN. Depending on the wireless utility, the user may only see the information except SSID or just cannot see anything about VigorAP 1000C while site surveying. The system allows you to set four sets of SSID for different usage.

<b>SSID</b>	Set a name for VigorAP 1000C to be identified. Default settings are DrayTek-LAN-A and DrayTek-LAN-B. When <b>Enable 2 Subnet</b> is enabled, you can specify subnet interface (LAN-A or LAN-B) for each SSID by using the drop down menu.
<b>Subnet</b>	Choose LAN-A or LAN-B for each SSID. If you choose LAN-A, the wireless clients connecting to this SSID could only communicate with LAN-A.
<b>Isolate LAN</b>	Check this box to isolate the wireless connection from LAN. It can make the wireless clients (stations) with remote-dial and LAN to LAN users not accessing for each other.
<b>Isolate Member</b>	Check this box to make the wireless clients (stations) with the same SSID not access for each other.
<b>VLAN ID</b>	Type the value for such SSID. Packets transferred from such SSID to LAN will be tagged with the number.  If your network uses VLANs, you can assign the SSID to a VLAN on your network. Client devices that associate using the SSID are grouped into this VLAN. The VLAN ID range is from 3 to 4095. The VLAN ID is 0 by default, it means disabling the VLAN function for the SSID.
<b>PHY Mode</b>	Data will be transmitted via HTMIX mode.  Each access point should be setup to the same <b>PHY Mode</b> for connecting with each other.
<b>Security</b>	Select WEP, TKIP or AES as the encryption algorithm.  Type <b>8~63</b> ASCII characters, such as 012345678..(or 64 Hexadecimal digits leading by 0x, such as "0x321253abcde...").
<b>Peer MAC Address</b>	Type the peer MAC address for the access point that VigorAP 902 connects to.

After finishing this web page configuration, please click **OK** to save the settings.

## II-3-2 Security

This page allows you to set security with different modes for SSID 1, 2, 3 and 4 respectively. After configuring the correct settings, please click **OK** to save and invoke it.

By clicking the **Security Settings**, a new web page will appear so that you could configure the settings.

Wireless LAN (2.4GHz) >> Security Settings

SSID 1	SSID 2	SSID 3	SSID 4
SSID	DrayTek-04F2C8		
Mode	WPA3/WPA2 Personal		
Set up <a href="#">RADIUS Server</a> if 802.1x is enabled.			
<b>WPA</b>			
WPA Algorithms	<input type="radio"/> TKIP	<input checked="" type="radio"/> AES	<input type="radio"/> TKIP/AES
Pass Phrase	<input type="password" value="....."/>		
Key Renewal Interval	<input type="text" value="3600"/>	seconds	
EAPOL Key Retry	<input checked="" type="radio"/> Enable	<input type="radio"/> Disable	
<b>WEP</b>			
<input type="radio"/> Key 1 :	<input type="text"/>	<input type="text" value="Hex"/>	
<input type="radio"/> Key 2 :	<input type="text"/>	<input type="text" value="Hex"/>	
<input type="radio"/> Key 3 :	<input type="text"/>	<input type="text" value="Hex"/>	
<input type="radio"/> Key 4 :	<input type="text"/>	<input type="text" value="Hex"/>	

Available settings are explained as follows:

Item	Description
<b>Mode</b>	<p>There are several modes provided for you to choose.</p> <p><u>Below shows the modes with higher security:</u></p> <ul style="list-style-type: none"> <li> <b>WPA3 Personal, WPA3/WPA2 Personal, WPA2 Personal, WPA2/WPA Personal</b> - Accepts only WPA clients and the encryption key should be entered in PSK. The WPA encrypts each frame transmitted from the radio using the key, which either PSK (Pre-Shared Key) entered manually in this field below or automatically negotiated via 802.1x authentication.                     </li> </ul> <p>The WPA encrypts each frame transmitted from the radio using the key, which either PSK (Pre-Shared Key) entered manually in this field below or automatically negotiated via 802.1x authentication. Select WPA, WPA2 or Auto as WPA mode.</p>

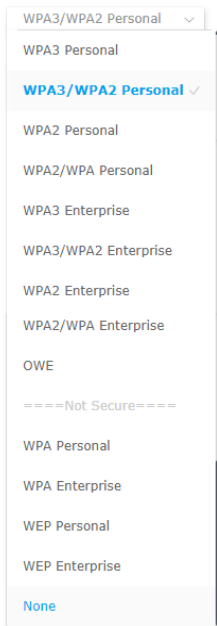

- **WPA3 Enterprise, WPA3/WPA2 Enterprise, WPA2 Enterprise, WPA2/WPA Enterprise** - The WPA encrypts each frame transmitted from the radio using the key, which either PSK (Pre-Shared Key) entered manually in this field below or automatically negotiated via 802.1x authentication.
- **WPA2 Enterprise** - The WPA encrypts each frame transmitted from the radio using the key, which either PSK (Pre-Shared Key) entered manually in this field below or automatically negotiated via 802.1x authentication.
- **OWE** - WPA3 also introduces a new open and secure connection mode; "Opportunistic Wireless Encryption" (OWE). It allows the clients to connect without a password, ideal for hotspot networks, but the connection between each individual client is uniquely encrypted behind the scenes.

Below shows the modes with basic security:

- **WPA Personal** - Accepts only WPA clients and the encryption key should be entered in PSK. The WPA encrypts each frame transmitted from the radio using the key, which either PSK (Pre-Shared Key) entered manually in this field below or automatically negotiated via 802.1x authentication.
- **WPA Enterprise** - The WPA encrypts each frame transmitted from the radio using the key, which either PSK (Pre-Shared Key) entered manually in this field below or automatically negotiated via 802.1x authentication.
- **WEP Personal** - Accepts only WEP clients and the encryption key should be entered in WEP Key.
- **WEP Enterprise** - The built-in RADIUS client feature enables VigorAP 960C to assist the remote dial-in user or a wireless station and the RADIUS server in performing mutual authentication. It enables centralized remote access authentication for network management.
- **None** - The encryption mechanism is turned off.

<p><b>WPA Algorithms</b></p>	<p>This feature is available for <b>WPA3 Enterprise, WPA2 Enterprise, WPA Enterprise, WPA3 Personal, WPA2 Personal, WPA Personal, WPA3/WPA2 Personal, or WPA2/WPA Personal</b> mode.</p> <p>Select TKIP, AES or TKIP/AES as the algorithm for WPA.</p> <p>Note that not all modes of Vigor router supports WPA3 mode. However, if the Vigor router supports WPA3 Personal/Enterprise security mode, the WPA algorithms will be set as AES.</p>
<p><b>Pass Phrase</b></p>	<p>Type <b>8~63</b> ASCII characters, such as 012345678..(or 64 Hexadecimal digits leading by 0x, such as "0x321253abcde..."). This feature is available for <b>WPA Personal or WPA2 Personal or WPA2 / WPA Personal</b> mode, <b>WPA3 Personal</b> or <b>WPA3/WPA2 Personal</b>.</p>
<p><b>Key Renewal Interval</b></p>	<p>WPA uses shared key for authentication to the network. However, normal network operations use a different encryption key that is randomly generated. This randomly generated key that is periodically replaced. Enter the renewal security time (seconds) in the column. Smaller interval leads to greater security but lower performance. Default is 3600 seconds. Set 0 to disable re-key. This feature is available for <b>WPA3 Enterprise, WPA2 Enterprise, WPA Enterprise, WPA3 Personal, WPA2 Personal, WPA Personal, WPA3/WPA2 Enterprise, WPA2/WPA Enterprise, WPA3/WPA2 Personal, or WPA2/WPA Personal</b> mode.</p>

<b>EAPOL Key Retry</b>	EAPOL means Extensible Authentication Protocol over LAN. Click <b>Enable</b> to make sure that the key will be installed and used once in order to prevent key reinstallation attack.
<b>Key 1 – Key 4</b>	Four keys can be entered here, but only one key can be selected at a time. The format of WEP Key is restricted to 5 ASCII characters or 10 hexadecimal values in 64-bit encryption level, or restricted to 13 ASCII characters or 26 hexadecimal values in 128-bit encryption level. The allowed content is the ASCII characters from 33(!) to 126(~) except '#' and ','. Such feature is available for <b>WEP</b> mode.

Click the link of **RADIUS Server** to access into the following page for more settings.

Available settings are explained as follows:

Item	Description
<b>Use internal RADIUS Server</b>	There is a RADIUS server built in VigorAP 1000C which is used to authenticate the wireless client connecting to the access point. Check this box to use the internal RADIUS server for wireless security. Besides, if you want to use the external RADIUS server for authentication, do not check this box. Please refer to the section, <b>IV-1-1 RADIUS Server</b> to configure settings for internal server of VigorAP 1000C.
<b>IP Address</b>	Enter the IP address of external RADIUS server.
<b>Port</b>	The UDP port number that the external RADIUS server is using. The default value is 1812, based on RFC 2138.
<b>Shared Secret</b>	The external RADIUS server and client share a secret that is used to authenticate the messages sent between them. Both sides must be configured to use the same shared secret.
<b>Session Timeout</b>	Set the maximum time of service provided before re-authentication. Set to zero to perform another authentication immediately after the first authentication has successfully completed. (The unit is second.)

After finishing this web page configuration, please click **OK** to save the settings.

## II-3-3 Access Control

For additional security of wireless access, the **Access Control** facility allows you to restrict the network access right by controlling the wireless LAN MAC address of client. Only the valid MAC address that has been configured can access the wireless LAN interface. By clicking the **Access Control**, a new web page will appear, as depicted below, so that you could edit the clients' MAC addresses to control their access rights (deny or allow).

Wireless LAN (2.4GHz) >> Access Control

SSID 1	SSID 2	SSID 3	SSID 4						
SSID: DrayTek-04F2C8 Policy: <input type="text" value="Disable"/>									
<b>MAC Address Filter</b>									
<table border="1"> <thead> <tr> <th>Index</th> <th>MAC Address</th> <th>access comment</th> </tr> </thead> <tbody> <tr> <td colspan="3" style="height: 100px;"> </td> </tr> </tbody> </table>				Index	MAC Address	access comment			
Index	MAC Address	access comment							
<input type="radio"/> MAC <input checked="" type="radio"/> Object									
Device Group: <input type="text" value="None"/> or Device Object: <input type="text" value="None"/>									
<input type="button" value="Add"/> Limit: 256 entries									
<input type="button" value="OK"/> <input type="button" value="Cancel"/>									
Backup ACL Cfg : <input type="button" value="Backup"/>		Upload From File: <input type="button" value="Browse"/> <input type="text" value="..."/> <input type="button" value="Restore"/>							

Available settings are explained as follows:

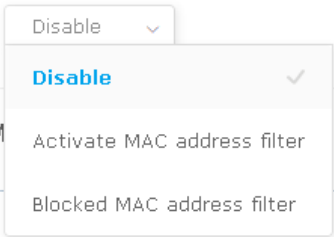
Item	Description
<b>Policy</b>	Select to enable any one of the following policy or disable the policy. Choose <b>Activate MAC address filter</b> to type in the MAC addresses for other clients in the network manually. Choose <b>Blocked MAC address filter</b> , so that all of the devices with the MAC addresses listed on the MAC Address Filter table will be blocked and cannot access into VigorAP 1000C. <div style="margin-top: 10px;">  </div>
<b>MAC Address Filter</b>	Display all MAC addresses that are edited before.

<b>MAC</b>	<p><b>Client's MAC Address</b> - Manually enter the MAC address of wireless client.</p> <p><b>Add</b> - Add a new MAC address into the list.</p> <p><b>Delete</b> - Delete the selected MAC address in the list.</p> <p><b>Edit</b> - Edit the selected MAC address in the list.</p>
<b>Object</b>	<p>In addition to enter the MAC address of the device manually, you can</p> <p><b>Device Group</b> - Select one of the existed device groups and click <b>Add</b>. All the devices belonging to the selected group will be shown on the MAC Address Filter table.</p> <p><b>Device Object</b> - Select one of the existed device object and click <b>Add</b>. The MAC address of the device will be shown on the MAC Address Filter table.</p>
<b>Cancel</b>	Give up the access control set up.
<b>Backup</b>	Click it to store the settings (MAC addresses on MAC Address Filter table) on this page as a file.
<b>Restore</b>	Click it to restore the settings (MAC addresses on MAC Address Filter table) from an existed file.

After finishing this web page configuration, please click **OK** to save the settings.

## II-3-4 WPS

Open **Wireless LAN>>WPS** to configure the corresponding settings.

### Wireless LAN (2.4GHz) >> WPS (Wi-Fi Protected Setup)

Enable WPS 

**Wi-Fi Protected Setup Information**

WPS Configured	Yes
WPS SSID	DrayTek-04F2C8
WPS Auth Mode	WPA3/WPA2 Personal
WPS Encrypt Type	AES

**Device Configure**

Configure via Push Button	<input type="button" value="Start PBC"/>
Configure via Client PinCode	<input type="text"/> <input type="button" value="Start PIN"/>

Status: The Authentication Mode is NOT WPA2/WPA Personal!!

**Note:** WPS can help your wireless client automatically connect to the Access point.

: WPS is Disabled.

: WPS is Enabled.

: Waiting for WPS requests from wireless clients.

Available settings are explained as follows:

Item	Description
<b>Enable WPS</b>	Check this box to enable WPS setting.
<b>WPS Configured</b>	Display related system information for WPS. If the wireless security

	(encryption) function of VigorAP 1000C is properly configured, you can see 'Yes' message here.
<b>WPS SSID</b>	Display current selected SSID.
<b>WPS Auth Mode</b>	Display current authentication mode of the VigorAP 1000C. Only WPA2/PSK and WPA/PSK support WPS.
<b>WPS Encrypt Type</b>	Display encryption mode (None, WEP, TKIP, AES, etc.) of VigorAP 1000C.
<b>Configure via Push Button</b>	Click <b>Start PBC</b> to invoke Push-Button style WPS setup procedure. VigorAP 1000C will wait for WPS requests from wireless clients about two minutes. Both ACT and 2.4G WLAN LEDs on VigorAP 1000C will blink quickly when WPS is in progress. It will return to normal condition after two minutes. (You need to setup WPS within two minutes)
<b>Configure via Client PinCode</b>	Type the PIN code specified in wireless client you wish to connect, and click <b>Start PIN</b> button. Both ACT and 2.4G WLAN LEDs on VigorAP 1000C will blink quickly when WPS is in progress. It will return to normal condition after two minutes. (You need to setup WPS within two minutes).



## II-3-5 Advanced Setting

This page is to determine which algorithm will be selected for wireless transmission rate.

### Wireless LAN (2.4GHz) >> Advanced Setting

Channel Bandwidth	<input type="radio"/> 20 MHz <input type="radio"/> Auto 20/40 MHz <input checked="" type="radio"/> 40 MHz
Antenna	<input checked="" type="radio"/> 2T2R <input type="radio"/> 1T1R
Tx Power	<input checked="" type="radio"/> 100% <input type="radio"/> 80% <input type="radio"/> 60% <input type="radio"/> 30% <input type="radio"/> 20% <input type="radio"/> 10%
Fragment Length (256 - 2346)	<input type="text" value="2346"/> bytes
RTS Threshold (1 - 2347)	<input type="text" value="2347"/> bytes
Country Code	<input type="text"/> (Reference)
Auto Channel Filtered Out List	<input type="checkbox"/> 1 <input type="checkbox"/> 2 <input type="checkbox"/> 3 <input type="checkbox"/> 4 <input type="checkbox"/> 5 <input type="checkbox"/> 6 <input type="checkbox"/> 7 <input type="checkbox"/> 8 <input type="checkbox"/> 9 <input type="checkbox"/> 10 <input type="checkbox"/> 11 <input type="checkbox"/> 12 <input type="checkbox"/> 13
IGMP Snooping	<input checked="" type="radio"/> Enable <input type="radio"/> Disable
Isolate 2.4GHz and 5GHz bands	<input checked="" type="radio"/> Enable <input type="radio"/> Disable
Isolate members with IP	<input type="radio"/> Enable <input checked="" type="radio"/> Disable
WMM Capable	<input checked="" type="radio"/> Enable <input type="radio"/> Disable
APSD Capable	<input type="radio"/> Enable <input checked="" type="radio"/> Disable
MAC Clone	<input type="radio"/> Enable <input checked="" type="radio"/> Disable <input type="text" value=""/>

**MAC Clone:** Set the MAC address of SSIDs and the Wireless client. Please notice that the last byte of this MAC address must be a multiple of 8.

Note: Fragment Length takes effect when mode is "11b Only" or "Mixed(11b+11g)".

Available settings are explained as follows:

Item	Description
<b>Channel Width</b>	<p><b>20 MHz-</b> The device will use 20MHz for data transmission and receiving between the AP and the stations.</p> <p><b>Auto 20/40 MHz-</b>The AP will scan for nearby wireless AP, and then use 20MHz if the number of AP is more than 10, or use 40MHz if it's not.</p> <p><b>40 MHz-</b> The device will use 40MHz for data transmission and receiving between the AP and the stations. It is for wireless LAN 2.4GHz only.</p> <p><b>Auto 20/40 /80 MHz -</b> The device will use 20/40/80 MHz channel bandwidth for data transmission and receiving between the AP and the stations.</p>
<b>Antenna (for 2.4GHz only)</b>	VigorAP can be attached with two antennas to have good data transmission via wireless connection. However, if you have only one antenna attached, please choose 1T1R.

<b>Tx Power</b>	The default setting is the maximum (100%). Lowering down the value may degrade range and throughput of wireless.
<b>Fragment Length</b>	Set the Fragment threshold of wireless radio. Do not modify default value if you don't know what it is, default value is 2346.
<b>RTS Threshold</b>	Minimize the collision (unit is bytes) between hidden stations to improve wireless performance. Set the RTS threshold of wireless radio. Do not modify default value if you don't know what it is, default value is 2347.
<b>Country Code</b>	VigorAP broadcasts country codes by following the 802.11d standard. However, some wireless stations will detect / scan the country code to prevent conflict occurred. If conflict is detected, wireless station will be warned and is unable to make network connection. Therefore, changing the country code to ensure successful network connection will be necessary for some clients.
<b>Auto Channel Filtered Out List</b>	The selected wireless channels will be discarded if <b>AutoSelect</b> is selected as <b>Channel</b> selection mode in <b>Wireless LAN&gt;&gt;General Setup</b> .
<b>IGMP Snooping</b>	Click <b>Enable</b> to enable IGMP Snooping. Multicast traffic will be forwarded to ports that have members of that group. Disabling IGMP snooping will make multicast traffic treated in the same manner as broadcast traffic.
<b>Isolate 2.4GHz and 5GHz bands</b>	The default setting is "Enable". It means that the wireless client using 2.4GHz band is unable to connect to the wireless client with 5GHz band, and vice versa. For WLAN 2.4GHz and 5GHz set with the same SSID name: <ul style="list-style-type: none"> <li>No matter such function is enabled or disabled, clients using WLAN 2.4GHz and 5GHz can communicate for each other if <b>Isolate Member</b> (in <b>Wireless LAN&gt;&gt;General Setup</b>) is NOT enabled for such SSID.</li> <li>Yet, if the function of <b>Isolate Member</b> (in <b>Wireless LAN&gt;&gt;General Setup</b>) is enabled for such SSID, clients using WLAN 2.4GHz and 5GHz will be unable to communicate with each other.</li> </ul>
<b>Isolate members with IP</b>	The default setting is "Disable". If it is enabled, VigorAP will isolate different wireless clients according to their IP address(es).
<b>WMM Capable</b>	To apply WMM parameters for wireless data transmission, please click the <b>Enable</b> radio button.
<b>APSD Capable</b>	APSD (automatic power-save delivery) is an enhancement over the power-save mechanisms supported by Wi-Fi networks. It allows devices to take more time in sleeping state and consume less power to improve the performance by minimizing transmission latency. The default setting is <b>Disable</b> .
<b>MAC Clone (for 2.4GHz only)</b>	Click <b>Enable</b> and manually enter the MAC address of the device with SSID 1. The MAC address of other SSIDs will change based on this MAC address.

After finishing this web page configuration, please click **OK** to save the settings.

## II-3-6 AP Discovery

VigorAP 1000C can scan all regulatory channels and find working APs in the neighborhood. Based on the scanning result, users will know which channel is clean for usage. Also, it can be used to facilitate finding an AP for a WDS link. Notice that during the scanning process (about 5 seconds), no client is allowed to connect to VigorAP.

This page is used to scan the existence of the APs on the wireless LAN. Please click **Scan** to discover all the connected APs.

Wireless LAN (2.4GHz) >> Access Point Discovery

### Access Point List

Select	Index	SSID	BSSID	RSSI	Channel	Encryption	Authentication
<input type="radio"/>	1		12:1D:AA:04:F0:6C	25%(-84dbm)	11	AES	WPA2/PSK
<input type="radio"/>	2	Ting_VC_2....	00:1D:AA:E4:8E:80	11%(-88dbm)	11	TKIP/AES	Mixed(WPA+WPA2)/PSK
<input type="radio"/>	3	DrayTek-04...	00:1D:AA:04:F0:6C	22%(-85dbm)	11	TKIP/AES	Mixed(WPA+WPA2)/PSK
<input type="radio"/>	4	rd8-ap1000...	06:1D:AA:04:F0:6C	32%(-82dbm)	11	TKIP/AES	WPA2/PSK
<input type="radio"/>	5		00:1D:AA:5E:D9:58	39%(-80dbm)	11	TKIP/AES	Mixed(WPA+WPA2)/PSK
<input type="radio"/>	6	rd8rd8	00:1D:AA:57:5D:38	53%(-76dbm)	11	TKIP/AES	Mixed(WPA+WPA2)/PSK
<input type="radio"/>	7	Ting_VC_2....	00:1D:AA:3D:4F:14	39%(-80dbm)	11	TKIP/AES	Mixed(WPA+WPA2)/PSK
<input type="radio"/>	8	Ting_VC_2....	02:50:7F:C1:91:E7	8%(-89dbm)	11	TKIP/AES	Mixed(WPA+WPA2)/PSK
<input type="radio"/>	9	DrayTek-LA...	00:1D:AA:22:33:44	15%(-87dbm)	11	TKIP/AES	Mixed(WPA+WPA2)/PSK
<input type="radio"/>	10	V2926_PQC_...	00:1D:AA:04:F0:D8	8%(-89dbm)	11	AES	WPA2/PSK
<input type="radio"/>	11	staffs	02:50:7F:C1:7F:1D	91%(-64dbm)	1	AES	WPA2/PSK
<input type="radio"/>	12	staffs	02:50:7F:C1:7E:CB	28%(-83dbm)	1	AES	WPA2/PSK
<input type="radio"/>	13	guests	02:50:7F:D1:7F:1D	90%(-65dbm)	1	AES	WPA2/PSK
<input type="radio"/>	14	guests	02:50:7F:D1:7E:CB	32%(-82dbm)	1	AES	WPA2/PSK
<input type="radio"/>	15	guests	02:50:7F:D1:7E:EC	4%(-91dbm)	1	AES	WPA2/PSK
<input type="radio"/>	16	DrayTek	00:1D:AA:92:6F:18	2%(-93dbm)	6	TKIP/AES	Mixed(WPA+WPA2)/PSK
<input type="radio"/>	17	DrayTek	00:1D:AA:CB:A3:10	8%(-89dbm)	6	TKIP/AES	Mixed(WPA+WPA2)/PSK
<input type="radio"/>	18	DrayTek	00:1D:AA:94:ED:E0	84%(-67dbm)	6	TKIP/AES	Mixed(WPA+WPA2)/PSK
<input type="radio"/>	19	DrayTek	00:50:7F:F0:D5:B5	11%(-88dbm)	11	TKIP/AES	Mixed(WPA+WPA2)/PSK
<input type="radio"/>	20	RD8_GW_24G...	00:1D:AA:5B:A0:C8	5%(-90dbm)	13	TKIP/AES	Mixed(WPA+WPA2)/PSK
<input type="radio"/>	21	staffs_2	00:1D:AA:62:0F:E8	19%(-86dbm)	3	AES	WPA2/PSK
<input type="radio"/>	22	staffs_2	02:50:7F:C1:7E:CF	92%(-63dbm)	3	TKIP/AES	WPA2/PSK
<input type="radio"/>	23	guests_2	02:50:7F:D1:7E:CF	91%(-64dbm)	3	TKIP/AES	WPA2/PSK
<input type="radio"/>	24	rd8rd8	00:1D:AA:7F:5D:8C	2%(-93dbm)	4	TKIP/AES	Mixed(WPA+WPA2)/PSK
<input type="radio"/>	25	guests_2	00:1D:AA:62:0F:E9	0%(-95dbm)	3	AES	WPA2/PSK
<input type="radio"/>	26		12:1D:AA:63:2C:00	25%(-84dbm)	9	AES	WPA2/PSK
<input type="radio"/>	27	PQC Mesh T...	00:1D:AA:63:2C:00	22%(-85dbm)	9	AES	WPA2/PSK
<input type="radio"/>	28	PQC-SmartP...	00:1D:AA:04:F0:DC	0%(-95dbm)	11	AES	Mixed(WPA+WPA2)/PSK
<input type="radio"/>	29	DrayTek-LA...	02:1D:AA:20:33:44	0%(-95dbm)	11	TKIP/AES	Mixed(WPA+WPA2)/PSK
<input type="radio"/>	30	V2860Ln_PQ...	00:1D:AA:DD:75:70	0%(-95dbm)	11	TKIP/AES	Mixed(WPA+WPA2)/PSK

V2860Ln\_PQC\_Justin\_2.4G

Scan

Note: During the scanning process (about 5 seconds), no station is allowed to connect with the AP.

Each item is explained as follows:

Item	Description
SSID	Display the SSID of the AP scanned by VigorAP 1000C.
BSSID	Display the MAC address of the AP scanned by VigorAP 1000C.
RSSI	Display the signal strength of the access point. RSSI is the abbreviation of Received Signal Strength Indication.
Channel	Display the wireless channel used for the AP that is scanned by VigorAP 1000C.
Encryption	Display the encryption mode for the scanned AP.
Authentication	Display the authentication type that the scanned AP applied.
Scan	It is used to discover all the connected AP. The results will be shown on the box above this button
AP's MAC Address / AP's SSID	Display the MAC address and SSID of the AP selected from the Access Point.

<b>Add</b>	Click it to add the AP selected from the Access Point List (with the same channel width) to the WDS Settings as peer' s setting.
------------	--

## II-3-7 WDS AP Status

VigorAP 1000C can display the status such as MAC address, physical mode, power save and bandwidth for the working AP connected with WDS. Click **Refresh** to get the newest information.

Wireless LAN (5GHz) >> WDS AP Status

WDS AP List

AID	MAC Address	802.11 Physical Mode	Power Save	Bandwidth
-----	-------------	----------------------	------------	-----------

Refresh

It is available for wireless LAN (5GHz) only.

## II-3-8 Bandwidth Management

The downstream or upstream from FTP, HTTP or some P2P applications will occupy large of bandwidth and affect the applications for other programs. Please use Bandwidth Management to make the bandwidth usage more efficient.

Wireless LAN (2.4GHz) >> Bandwidth Management

SSID 1	SSID 2	SSID 3	SSID 4
SSID		DrayTek-04F2C8	
Per Station Bandwidth Limit			
<b>Enable</b>		<input checked="" type="checkbox"/>	
Upload Limit	User defined	K	bps (Default unit : K)
Download Limit	User defined	K	bps (Default unit : K)
Auto Adjustment		<input checked="" type="checkbox"/>	
Total Upload Limit	User defined	K	bps (Default unit : K)
Total Download Limit	User defined	K	bps (Default unit : K)

Note: 1. Download : Traffic going to any station. Upload : Traffic being sent from a wireless station.  
2. Allow auto adjustment could make the best utilization of available bandwidth.

OK Cancel

Available settings are explained as follows:

Item	Description
<b>SSID</b>	Display the specific SSID name.
<b>Enable</b>	Check this box to enable the bandwidth management for clients.
<b>Upload Limit</b>	Define the maximum speed of the data uploading which will be used

	for the wireless stations connecting to Vigor device with the same SSID. Use the drop down list to choose the rate. If you choose <b>User defined</b> , you have to specify the rate manually.
<b>Download Limit</b>	Define the maximum speed of the data downloading which will be used for the wireless station connecting to Vigor device with the same SSID. Use the drop down list to choose the rate. If you choose <b>User defined</b> , you have to specify the rate manually.
<b>Auto Adjustment</b>	Check this box to have the bandwidth limit determined by the system automatically.
<b>Total Upload Limit</b>	When Auto Adjustment is checked, the value defined here will be treated as the total bandwidth shared by all of the wireless stations with the same SSID for data uploading.
<b>Total Download Limit</b>	When Auto Adjustment is checked, the value defined here will be treated as the total bandwidth shared by all of the wireless stations with the same SSID for data downloading.

After finishing this web page configuration, please click **OK** to save the settings.

## II-3-9 Airtime Fairness

Airtime fairness is essential in wireless networks that must support critical enterprise applications.

Most of the applications are either symmetric or require more downlink than uplink capacity; telephony and email send the same amount of data in each direction, while video streaming and web surfing involve more traffic sent from access points to clients than the other way around. This is essential for ensuring predictable performance and quality-of-service, as well as allowing 802.11n and legacy clients to coexist on the same network. Without airtime fairness, offices using mixed mode networks risk having legacy clients slow down the entire network or letting the fastest client(s) crowd out other users.

With airtime fairness, every client at a given quality-of-service level has equal access to the network's airtime.

The wireless channel can be accessed by only one wireless station at the same time.

The principle behind the IEEE802.11 channel access mechanisms is that each station has **equal probability** to access the channel. When wireless stations have similar data rate, this principle leads to a fair result. In this case, stations get similar channel access time which is called airtime.

However, when stations have various data rate (e.g., 11g, 11n), the result is not fair. The slow stations (11g) work in their slow data rate and occupy too much airtime, whereas the fast stations (11n) become much slower.

Take the following figure as an example, both Station A(11g) and Station B(11n) transmit data packets through VigorAP 1000C. Although they have equal probability to access the wireless channel, Station B(11n) gets only a little airtime and waits too much because Station A(11g) spends longer time to send one packet. In other words, Station B(fast rate) is obstructed by Station A(slow rate).

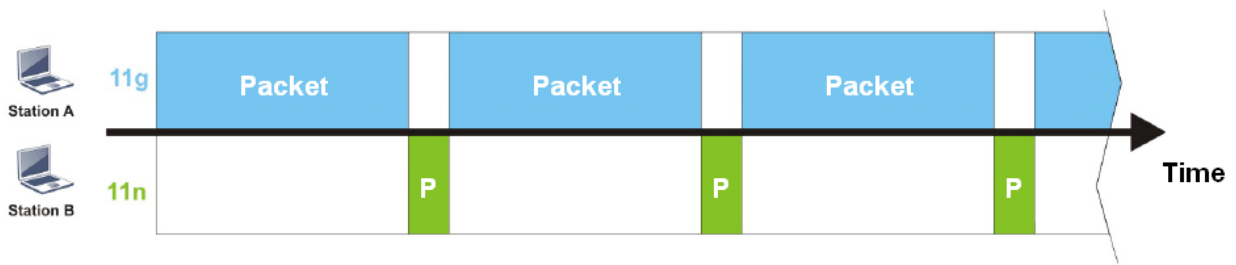

To improve this problem, Airtime Fairness is added for VigorAP 1000C. Airtime Fairness function tries to assign *similar airtime* to each station (A/B) by controlling TX traffic. In the following figure, Station B(11n) has higher probability to send data packets than Station A(11g). By this way, Station B(fast rate) gets fair airtime and it's speed is not limited by Station A(slow rate).

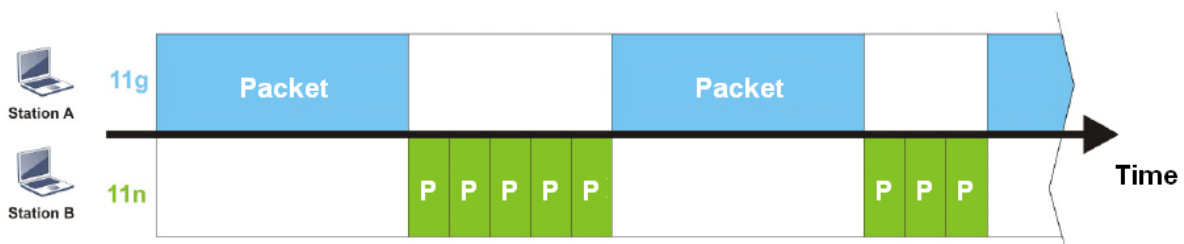

It is similar to automatic Bandwidth Limit. The dynamic bandwidth limit of each station depends on instant active station number and airtime assignment. Please note that Airtime Fairness of 2.4GHz and 5GHz are independent. But stations of different SSIDs function together, because they all use the same wireless channel. IN SPECIFIC ENVIRONMENTS, this function can reduce the bad influence of slow wireless devices and improve the overall wireless performance.

Suitable environment:

- (1) Many wireless stations.
- (2) All stations mainly use download traffic.
- (3) The performance bottleneck is wireless connection.

**Wireless LAN (2.4GHz) >> Airtime Fairness**

Enable [Airtime Fairness](#)

Triggering Client Number  (2 ~ 128, Default: 2)

**Note:** Please enable or disable this function according to the real situation and user experience. It is NOT suitable for all environments.

Available settings are explained as follows:

Item	Description
<b>Enable Airtime Fairness</b>	Try to assign similar airtime to each wireless station by controlling TX traffic. <b>Airtime Fairness</b> – Click the link to display the following screen of airtime fairness note.

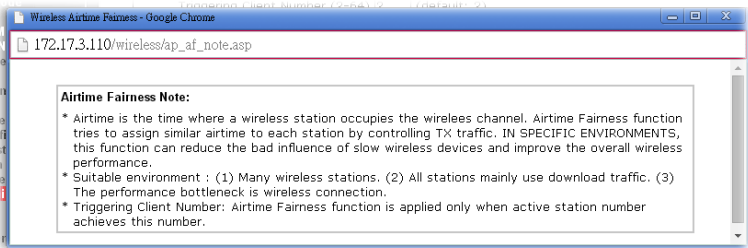

**Triggering Client Number** –Airtime Fairness function is applied only when active station number achieves this number.

After finishing this web page configuration, please click **OK** to save the settings.

**i** Note:

Airtime Fairness function and Bandwidth Limit function should be mutually exclusive. So their webs have extra actions to ensure these two functions are not enabled simultaneously.

## II-3-10 Station Control

Station Control is used to specify the duration for the wireless client to connect and reconnect VigorAP. If such function is not enabled, the wireless client can connect VigorAP until it shuts down.

Such feature is especially useful for free Wi-Fi service. For example, a coffee shop offers free Wi-Fi service for its guests for one hour every day. Then, the connection time can be set as “1 hour” and reconnection time can be set as “1 day”. Thus, the guest can finish his job within one hour and will not occupy the wireless network for a long time.

**i** Note:

Up to 300 Wireless Station records are supported by VigorAP.

### Wireless LAN (2.4GHz) >> Station Control

SSID 1	SSID 2	SSID 3	SSID 4
SSID	DrayTek-04F2C8		
Enable	<input type="checkbox"/>		
Connection Time	1 hour ▾		
Reconnection Time	1 day ▾		
<a href="#">Display All Station Control List</a>			

**Note:** Once the feature is enabled, the connection time quota will apply to each wireless client (identified by MAC address).

OK Cancel

Available settings are explained as follows:

<b>Item</b>	<b>Description</b>
<b>SSID</b>	Display the SSID that the wireless station will use it to connect with Vigor router.
<b>Enable</b>	Check the box to enable the station control function.
<b>Connection Time / Reconnection Time</b>	Use the drop down list to choose the duration for the wireless client connecting /reconnecting to Vigor device. Or, type the duration manually when you choose <b>User defined</b> .
<b>Display All Station Control List</b>	All the wireless stations connecting to Vigor router by using such SSID will be listed on Station Control List.

After finishing all the settings here, please click **OK** to save the configuration.



## II-3-11 Roaming

The network signal for a single wireless access point might be limited by its coverage range. Therefore, if you want to expand the wireless network in a large exhibition with a quick method, you can install multiple access points with enabling the Roaming feature for each AP to reach the purpose of expanding wireless signals seamlessly.

These access points connecting for each other shall be verified by pre-authentication. This page allows you to enable the roaming feature and the pre-authentication.

### Wireless LAN (2.4GHz) >> Roaming

#### AP-assisted Client Roaming Parameters

**Minimum Basic Rate**  Mbps

---

**Disable RSSI Requirement**

**Strictly Minimum RSSI**  dBm ( %) (Default: -73)

**Minimum RSSI**  dBm ( %) (Default: -66)  
with Adjacent AP RSSI over  dB (Default: 5)

#### Fast Roaming(WPA2 Enterprise)

**Enable**

**PMK Caching : Cache Period**  minutes (10 ~ 600, Default: 10)  
**Pre-Authentication**

Available settings are explained as follows:

Item	Description
<b>AP-assisted Client Roaming Parameters</b>	<p>When the link rate of wireless station is too low or the signal received by the wireless station is too worse, VigorAP 1000C will automatically detect (based on the link rate and RSSI requirement) and cut off the network connection for that wireless station to assist it to connect another Wireless AP to get better signal.</p> <p><b>Minimum Basic Rate</b> – Check the box to use the drop down list to specify a basic rate (<b>Mbps</b>). When the link rate of the wireless station is below such value, VigorAP 1000C will terminate the network connection for that wireless station.</p> <p><b>Disable RSSI Requirement</b> - If it is selected, VigorAP will not terminate the network connection based on RSSI.</p> <p><b>Strictly Minimum RSSI</b> - VigorAP uses RSSI (received signal strength indicator) to decide to terminate the network connection of wireless station. When the signal strength is below the value (<b>dBm</b>) set here, VigorAP 1000C will terminate the network connection for that wireless station.</p> <p><b>Minimum RSSI</b> - When the signal strength of the wireless station is below the value (<b>dBm</b>) set here and adjacent AP (must be DrayTek AP</p>

	<p>and support such feature too) with higher signal strength value (defined in the field of <b>With Adjacent AP RSSI over</b>) is detected by VigorAP 1000C, VigorAP 1000C will terminate the network connection for that wireless station. Later, the wireless station can connect to the adjacent AP (with better RSSI).</p> <ul style="list-style-type: none"> <li>● <b>With Adjacent AP RSSI over</b> – Specify a value as a threshold.</li> </ul>
<p><b>Fast Roaming (WPA2/802.1x)</b></p>	<p><b>Enable</b> – Check the box to enable fast roaming configuration.</p> <p><b>PMK Caching</b> - Set the expire time of WPA2 PMK (Pairwise master key) cache. PMK Cache manages the list from the BSSIDs in the associated SSID with which it has pre-authenticated. Such feature is available for <b>WPA2/802.1</b> mode.</p> <p><b>Pre-Authentication</b> - Enables a station to authenticate to multiple APs for roaming securer and faster. With the pre-authentication procedure defined in IEEE 802.11i specification, the pre-four-way-handshake can reduce handoff delay perceivable by a mobile node. It makes roaming faster and more secure. (Only valid in WPA2)</p> <p><b>Enable</b> - Enable IEEE 802.1X Pre-Authentication.</p> <p><b>Disable</b> - Disable IEEE 802.1X Pre-Authentication.</p>

After finishing this web page configuration, please click **OK** to save the settings.

## II-3-12 Band Steering (for Wireless LAN (2.4GHz))

Band Steering detects if the wireless clients are capable of 5GHz operation, and steers them to that frequency. It helps to leave 2.4GHz band available for legacy clients, and improves users experience by reducing channel utilization.

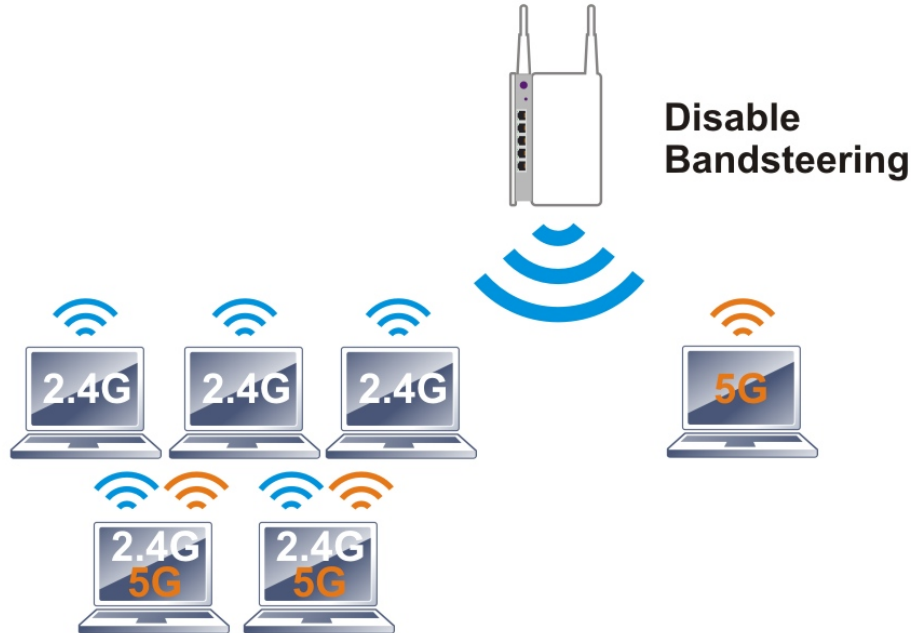

If dual-band is detected, the AP will let the wireless client connect to less congested wireless LAN, such as 5GHz to prevent from network congestion.

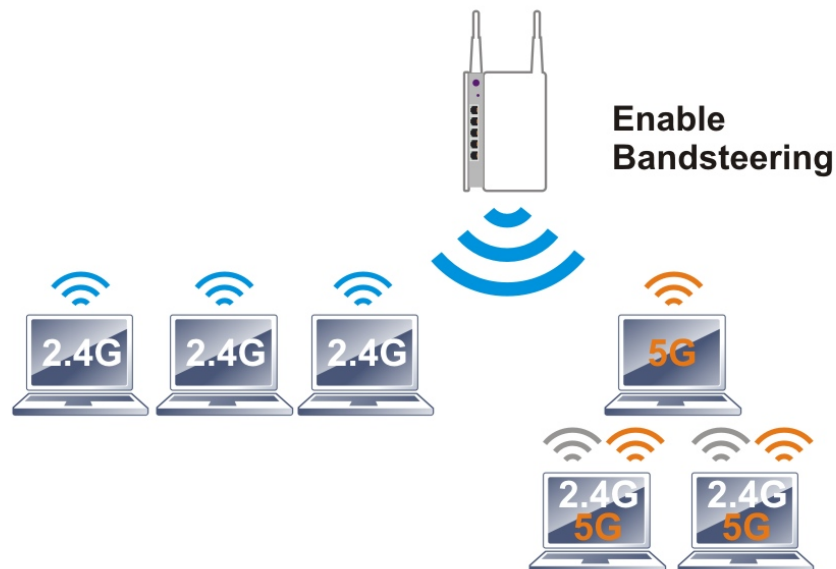

**Note:**

To make Band Steering work successfully, SSID and security on 2.4GHz also MUST be broadcasted on 5GHz / 5GHz-2.

Open **Wireless LAN (2.4GHz)>>Band Steering** to get the following web page:

**Wireless LAN (2.4GHz) >> Band Steering**

Enable **Band Steering**

Check Time for WLAN Client 5G Capability  seconds (1 ~ 60, Default: 15)

Wait Full Time to Check 5G Capability

5GHz Minimum RSSI  dBm ( %) (Default: -78)

(Only do band steering when 5GHz signal is better than Minimum RSSI)

Overloaded

2.4GHz Utilization Overload Threshold  % (Default: 70)

5GHz Utilization Overload Threshold  % (Default: 70)

(Only do band steering when 2.4GHz utilization is overloaded and 5GHz utilization is not)

**Note:** Please setup at least one pair of 2.4GHz and 5GHz Wireless LAN with the same SSID and security.

Available settings are explained as follows:

Item	Description
<b>Enable Band Steering</b>	<p>If it is enabled, VigorAP will detect if the wireless client is capable of dual-band or not within the time limit.</p> <p><b>Check Time....</b> – If the wireless station does not have the capability of 5GHz network connection, the system shall wait and check for several seconds (15 seconds, in default) to make the 2.4GHz network connection. Specify the time limit for VigorAP to detect the wireless client.</p> <p><b>Wait Full Time to Check 5G Capability</b> – If enabled, the client trying to connect to wireless network 2.4G has to wait for a few seconds (defined in <b>Check Time...</b> above) to check if the connecting device has the 5G capability. If no 5G capability, the client will be directed to the wireless 2.4G network.</p> <p><b>5GHz Minimum RSSI</b> – The wireless station has the capability of 5GHz network connection, yet the signal performance might not be satisfied. Therefore, when the signal strength is below the value set here while the wireless station connecting to VigorAP 920RP, VigorAP will allow the client to connect to 2.4GHz network.</p> <p><b>Overloaded</b> – If it is enabled, VigorAP will activate the band steering</p>

according to the conditions set below.

- **2.4GHz Utilization Overload Threshold** – The default setting is 70%. It can define the network congestion for 2.4GHz.
- **5GHz Utilization Overload Threshold** – The default setting is 70%. It can define the network congestion for 5GHz.

When the utilization of 2.4GHz is higher than the specified threshold and the utilization of 5GHz is lower than the specified threshold, VigorAP will steer the client to connect to 5GHz network.

After finishing this web page configuration, please click **OK** to save the settings.

Below shows how Band Steering works.

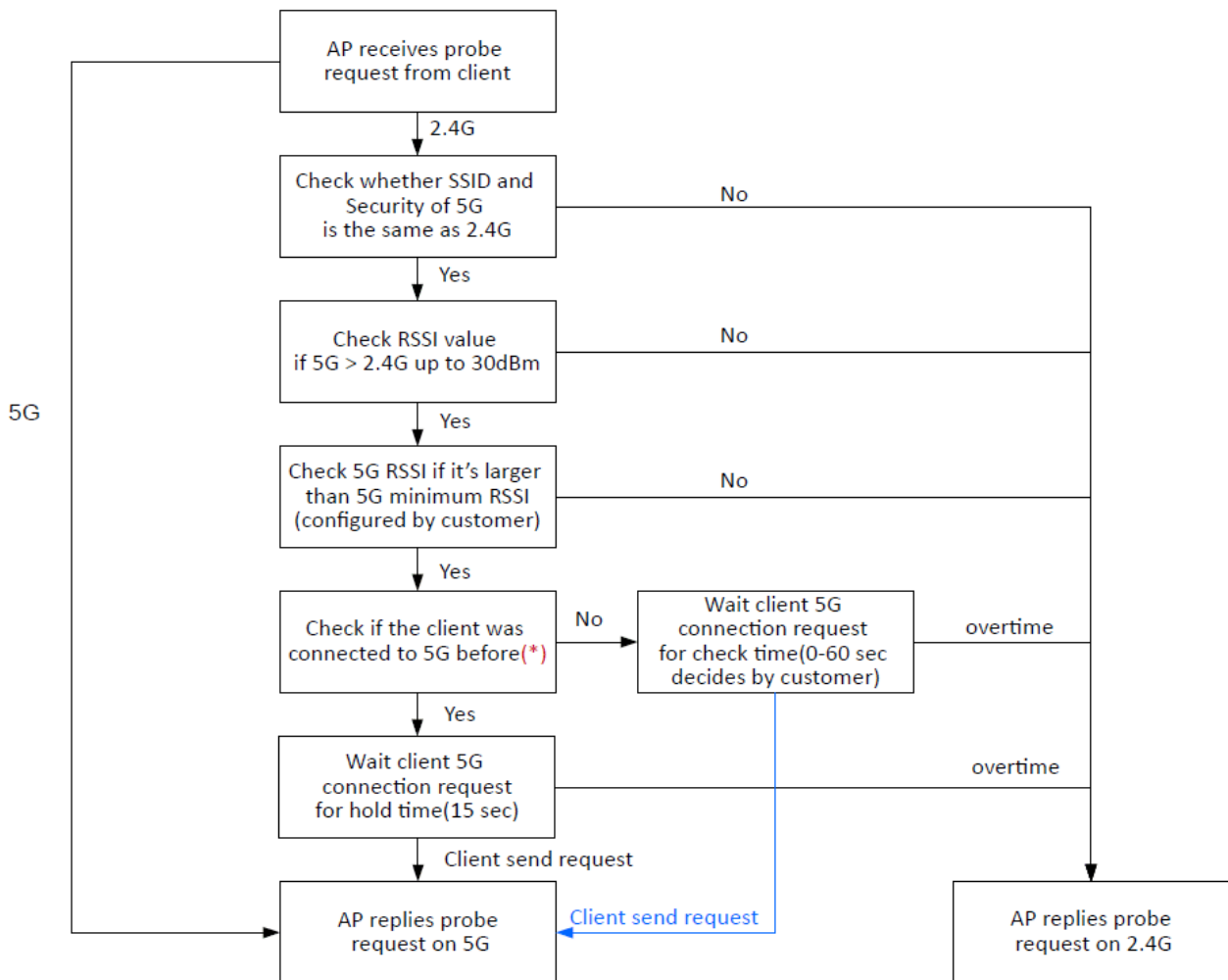

\* AP will clear the 5G history station list every 2.5 mins.

## How to Use Band Steering?

1. Open **Wireless LAN(2.4GHz)>>Band Steering**.
2. Check the box of **Enable Band Steering** and use the default value (15) for check time setting.

### Wireless LAN (2.4GHz) >> Band Steering

Enable **Band Steering**

Check Time for WLAN Client 5G Capability  seconds (1 ~ 60, Default: 15)

Wait Full Time to Check 5G Capability

3. Click **OK** to save the settings.
4. Open **Wireless LAN (2.4GHz)>>General Setup**, **Wireless LAN (5GHz)>>General Setup**, and **Wireless LAN (5GHz-2) >>General Setup**. Configure SSID as *ap1000-BandSteering* for these pages. Click **OK** to save the settings.

### Wireless LAN (2.4GHz) >> General Setup

#### General Setting ( IEEE 802.11 )

Enable Wireless LAN

Enable Client Limit  (3 ~ 128, default: 128)

Enable Client Limit per SSID (3 ~ 128, default: 128)

Mode :

Channel :  (Active Channel)

Extension Channel :

Enable 2 Subnet (Simulate 2 APs)

Enable	Hide SSID	SSID	Subnet	Isolate LAN Member
<input type="checkbox"/>	<input type="checkbox"/>	ap1000-BandSteering	LAN-A	<input type="checkbox"/>
<input type="checkbox"/>	<input type="checkbox"/>	LAN-A	LAN-A	<input type="checkbox"/>

### Wireless LAN (5GHz) >> General Setup

#### General Setting ( IEEE 802.11 )

Enable Wireless LAN

Enable Client Limit  (3 ~ 128, default: 128)

Enable Client Limit per SSID (3 ~ 128, default: 128)

Mode :

Channel :  (Active Channel: 44)

Details : [DFS] 20/40MHz Ext Ch: 56 , 80MHz Center Ch: 58

Enable 2 Subnet (Simulate 2 APs)

Enable	Hide SSID	SSID	Subnet	Isolate LAN Member	VLAN ID (0:Untagged)
<input type="checkbox"/>	<input type="checkbox"/>	ap1000-BandSteering	LAN-A	<input type="checkbox"/>	<input type="text" value="0"/>
<input type="checkbox"/>	<input type="checkbox"/>	LAN-A	LAN-A	<input type="checkbox"/>	<input type="text" value="0"/>

### Wireless LAN (5GHz-2) >> General Setup

#### General Setting ( IEEE 802.11 )

Enable Wireless LAN

Enable Client Limit  (3 ~ 128, default: 128)

Enable Client Limit per SSID (3 ~ 128, default: 128)

Mode :

Channel :  (Active Channel: 100)

Details : [DFS] 20/40MHz Ext Ch:104 , 80MHz Center Ch:106

Enable 2 Subnet (Simulate 2 APs)

Enable	Hide SSID	SSID	Subnet	Isolate LAN Member	VLAN ID (0:Untagged)
<input type="checkbox"/>	<input type="checkbox"/>	ap1000-BandSteering	LAN-A	<input type="checkbox"/>	<input type="text" value="0"/>
<input type="checkbox"/>	<input type="checkbox"/>	LAN-A	LAN-A	<input type="checkbox"/>	<input type="text" value="0"/>

Same value for 2.4GHz, 5GHz and 5GHz-2

- Open **Wireless LAN (2.4GHz)>>General Setup**, **Wireless LAN (5GHz)>>General Setup**, and **Wireless LAN (5GHz-2)>>General Setup**. Configure Security as 12345678 for these pages. Click **OK** to save the settings.

**Wireless LAN (2.4GHz) >> Security Settings**

SSID 1	SSID 2	SSID 3	SSID 4
SSID			
ap1000-BandSteering			
Mode			
WPA2/PSK			
Set up <a href="#">RADIUS Server</a> if 802.1x is enabled.			
<b>WPA</b>			
WPA Algorithms			
<input type="radio"/> TKIP <input checked="" type="radio"/> AES <input type="radio"/> TKIP/AES			
Pass Phrase			
<input type="text" value="....."/>			
Key Renewal Interval			
<input type="text" value="3600"/> seconds			
EAPOL Key Retry			
<input checked="" type="radio"/> Enable <input type="radio"/> Disable			

**Wireless LAN (5GHz) >> Security Settings**

**WEP**

Key 1 :

SSID 1	SSID 2	SSID 3	SSID 4
SSID			
ap1000-BandSteering			
Mode			
WPA2/PSK			
Set up <a href="#">RADIUS Server</a> if 802.1x is enabled.			
<b>WPA</b>			
WPA Algorithms			
<input type="radio"/> TKIP <input checked="" type="radio"/> AES <input type="radio"/> TKIP/AES			
Pass Phrase			
<input type="text" value="....."/>			
Key Renewal Interval			
<input type="text" value="3600"/> seconds			
EAPOL Key Retry			
<input checked="" type="radio"/> Enable <input type="radio"/> Disable			

**Wireless LAN (5GHz-2) >> Security Settings**

SSID 1	SSID 2	SSID 3	SSID 4
SSID			
ap1000-BandSteering			
Mode			
WPA2/PSK			
Set up <a href="#">RADIUS Server</a> if 802.1x is enabled.			
<b>WPA</b>			
WPA Algorithms			
<input type="radio"/> TKIP <input checked="" type="radio"/> AES <input type="radio"/> TKIP/AES			
Pass Phrase			
<input type="text" value="....."/>			
Key Renewal Interval			
<input type="text" value="3600"/> seconds			
EAPOL Key Retry			
<input checked="" type="radio"/> Enable <input type="radio"/> Disable			
<b>WEP</b>			
<input checked="" type="radio"/> Key 1 : <input type="text" value=""/>			

Same value for 2.4GHz, 5GHz and 5GHz-2

- Now, VigorAP 1000C will let the wireless clients connect to less congested wireless LAN, such as 5GHz to prevent from network congestion.

## II-3-13 Station List

**Station List** provides the information related to the number of clients connecting to VigorAP, used bandwidth and the statistics of the AP device OS. Besides, users can create access control policies, device objects and set black & white list for

### II-3-13-1 Connected Number

This page lists the graph for the number of wireless stations connected to this Access Point with different time phases.

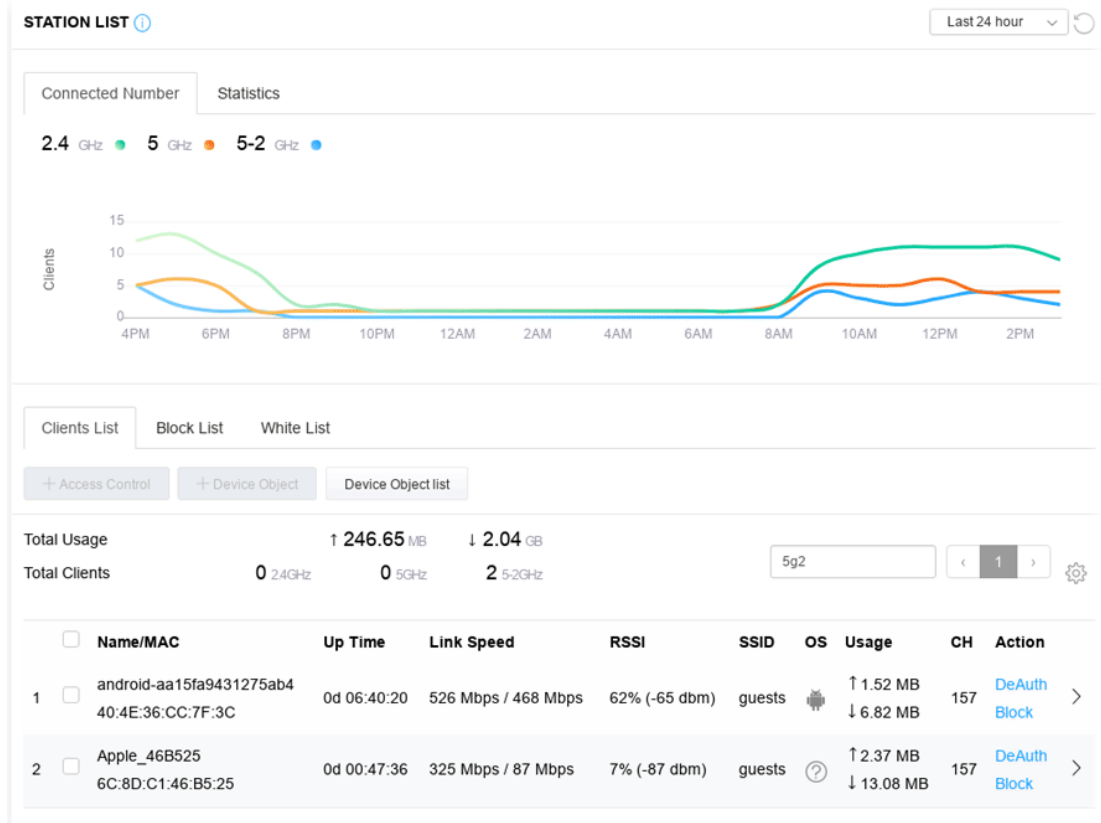



## II-3-13-2 Statistics

The number of detected devices and the number of device(s) passed/blocked according to the policy specified in **Mobile Device Management>>Policy** can be illustrated as doughnut chart.

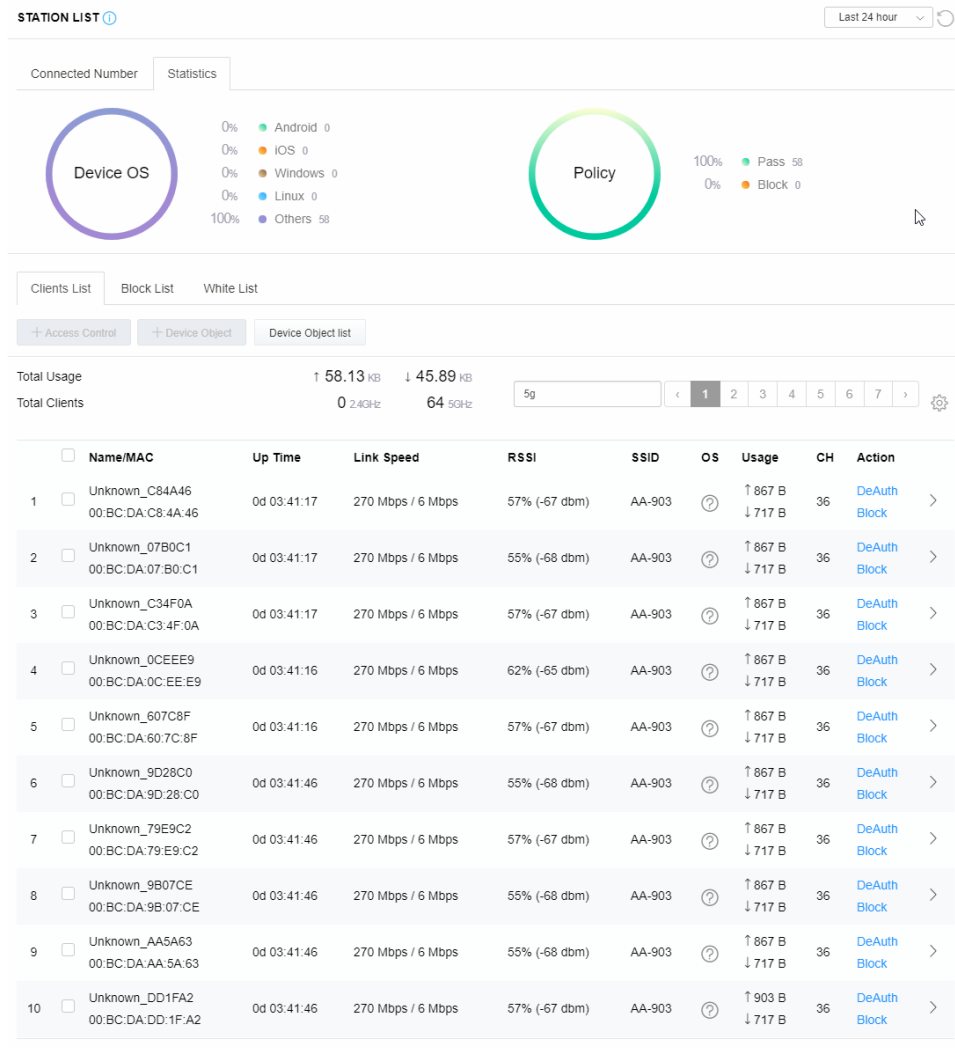

### II-3-13-3 Clients List

The client list displays all the stations connecting to VigorAP.

**STATION LIST** ⓘ Last 24 hour ↻

---

Connected Number Statistics

**Device OS**

- 0% Android 0
- 0% iOS 0
- 0% Windows 0
- 0% Linux 0
- 100% Others 58

**Policy**

- 100% Pass 58
- 0% Block 0

---

Clients List Block List White List

+ Access Control + Device Object Device Object list

---

Total Usage ↑ 58.13 KB ↓ 45.89 KB

Total Clients 0 2.4GHz 64 5GHz 5g < 1 2 3 4 5 6 7 > ⚙️

<input type="checkbox"/>	Name/MAC	Up Time	Link Speed	RSSI	SSID	OS	Usage	CH	Action
<input type="checkbox"/>	Unknown_C84A46 00:BC:DA:C8:4A:46	0d 03:42:47	270 Mbps / 6 Mbps	57% (-67 dbm)	AA-903	?	↑ 867 B ↓ 717 B	36	DeAuth Block
<input checked="" type="checkbox"/>	Unknown_07B0C1 00:BC:DA:07:B0:C1	0d 03:42:47	270 Mbps / 6 Mbps	55% (-68 dbm)	AA-903	?	↑ 867 B ↓ 717 B	36	DeAuth Block
<input checked="" type="checkbox"/>	Unknown_C34F0A 00:BC:DA:C3:4F:0A	0d 03:42:47	270 Mbps / 6 Mbps	57% (-67 dbm)	AA-903	?	↑ 867 B ↓ 717 B	36	DeAuth Block
<input type="checkbox"/>	Unknown_0CEEE9 00:BC:DA:0C:EE:E9	0d 03:42:46	270 Mbps / 6 Mbps	62% (-65 dbm)	AA-903	?	↑ 867 B ↓ 717 B	36	DeAuth Block

Available settings are explained as follows:

Item	Description
<b>+Access Control</b>	<p>It is available after choosing one of the entries (clients) on Clients List.</p> <p><b>Wireless LAN</b> - Specify the bandwidth for the access control list.</p> <p><b>SSID Policy</b> - Set the policy for each SSID as black list or white list or disable.</p> <p><b>From to list</b> - Display the clients available for applying this access</p>

	<p>control.</p> <p><b>Apply to SSID</b> - Check <b>All</b> to make the device apply the policies to all SSIDs. Or select the one(s) to make the device apply the policies to the selected SSIDs.</p> <p><b>Close</b> - Exit this page without saving any changes.</p> <p><b>Save changes</b> - Save the changes and exit this page.</p>
<p><b>+Device Object</b></p>	<p>To add a device to device object list, choose one of the entries (clients) on Clients List to enable the Device Object button. Click the button to open the following page.</p> <div data-bbox="651 555 1396 1008" data-label="Image"> </div> <p>Check the information listed on the page. Change the MAC address or name of the selected entry if required. Then click <b>OK</b> and exit the page.</p>
<p><b>Device Object list</b></p>	<p>The existed device object profiles will be shown on the following page.</p> <div data-bbox="643 1220 1396 1444" data-label="Image"> </div>
<p><b>Clients List</b></p>	<p>Display the stations connecting to this Vigor device.</p> <p><b>Total Usage</b> - Display</p> <p><b>Total Clients</b> - Display the number of the clients using 2.4GHz</p> <p><b>Name / MAC</b> - Display the host name / MAC address of the connecting client.</p> <p><b>Up Time</b> - Display the connection time.</p> <p><b>Link Speed</b>- Display the link speed.</p> <p><b>RSSI</b> - Display the RSSI value.</p> <p><b>SSID</b> - Display the SSID the client used for connecting VigorAP.</p> <p><b>OS</b> - Display the OS of the client.</p> <p><b>Usage</b> - Display the bandwidth usage (up and down) of the client.</p> <p><b>CH</b> - Display the channel used by the client.</p> <p><b>Action</b> - Display the authentication method used by the client, and if it is on block list or white list.</p>

### II-3-13-4 Block List

This page displays information of the stations under block list.

**STATION LIST** ⓘ Last 24 hour ↻

---

Connected Number Statistics

2.4 GHz ● 5 GHz ●

---

Clients List Block List White List

+ Access Control + Device Object Device Object list

Search ⚙

< 1 >

	Name / MAC	SSID	Reason	Action
1	Unknown_457823 00:BC:DB:45:78:23	AA-903	ACL	<a href="#">Unblock</a>
2	Unknown_A566C8 00:BC:DB:A5:66:C8	AA-903	ACL	<a href="#">Unblock</a>

Total list 2

Available settings are explained as follows:

Item	Description
<b>Device Object list</b>	Click it to open the Device Object List dialog for reference. 
<b>Name / MAC</b>	Display the host name / MAC Address for the connecting client.
<b>SSID</b>	Display the SSID that the wireless client connects to.
<b>Reason</b>	Display the reference information.
<b>Action</b>	Display the action that you can execute for the station. <b>Unblock</b> - Click to unblock the entry.

## II-3-13-5 White List

This page displays general information of the stations under white list.

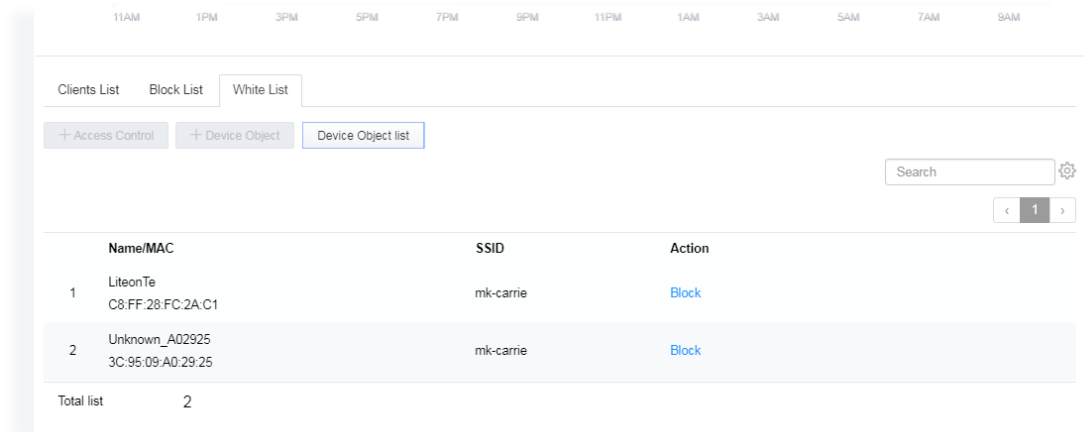

Available settings are explained as follows:

Item	Description
<b>Device Object list</b>	Click it to open the Device Object List dialog for reference. 
<b>Name / MAC</b>	Display the host name / MAC Address for the connecting client.
<b>SSID</b>	Display the SSID that the wireless client connects to.
<b>Action</b>	Display the action that you can execute for the station. <b>Block</b> - Click to block the entry.

## II-4 Mesh Settings for Mesh Mode

When you choose **Mesh** as the operation mode, the Mesh menu with the settings of Mesh Setup, Mesh Status, Mesh Discovery, Configuration Sync, Support List and Mesh Syslog will be shown on the screen.

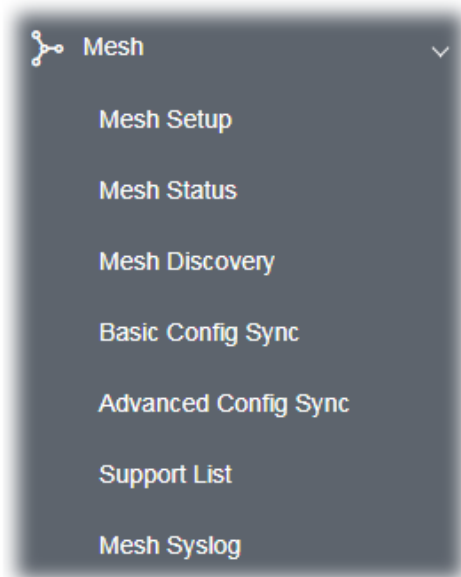

Please note that, within VigorMesh network,

- the total number allowed for mesh nodes is 8 (including the mesh root)
- the maximum number of hop is 3

Refer to the following figure:

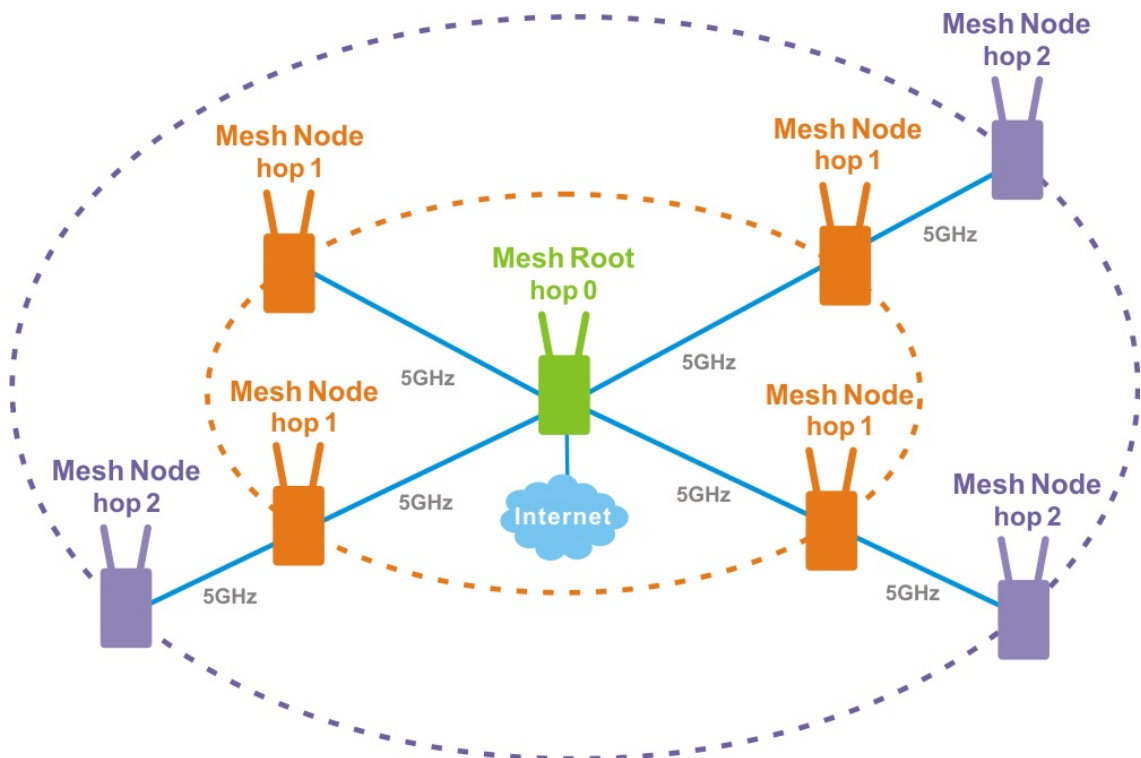

For the mesh group set within VigorMesh network,

- It must be composed by "1" Mesh Root and "0~7" mesh nodes
- (Roaming) Normally members in a mesh group use the same Wireless SSID/security
- (Add) Only the mesh root can add a new mesh node into the mesh group
- (Recover) A disconnected mesh node will automatically try to connect to another connected mesh node of the same group

### Mesh Root and Mesh Node

Mesh Root indicates that VigorAP would be other AP's uplink connection. As a Mesh Root, VigorAP must connect to a gateway with Ethernet cable first to have an internet connection.

As a Mesh Node, VigorAP can connect to the mesh root or mesh node within the same mesh group via wireless network or physical connection with an Ethernet cable.

The following figure shows how VigorAP runs as MESH ROOT:

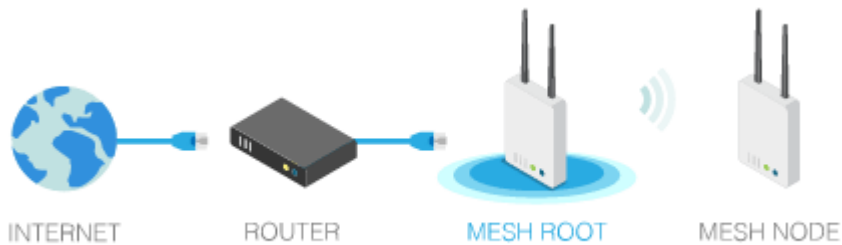

The following figure shows how VigorAP runs as MESH NODE:



## II-4-1 Mesh Setup

Such page can determine the role of the VigorAP connecting to the computer physically. For a mesh root, you can search and specify mesh nodes as members under current mesh group.

Mesh >> Mesh Setup

### General Setup

Role	<input checked="" type="radio"/> Mesh Root <input type="radio"/> Mesh Node
Wireless Downlink Band	Auto <input type="button" value="v"/>
Group Name	VigorMesh <input type="text"/>
Auto Reselect	<input checked="" type="checkbox"/>
Log Level	Detailed <input type="button" value="v"/>

### Mesh Group

Select	Index	Role	MAC Address	Model	CFG Sync	CFG Check	Device Name
<input type="checkbox"/>	1	Root	00:1D:AA:04:F2:C8	VigorAP1000C	<input type="checkbox"/>	<input type="checkbox"/>	

OK

Cancel

### Add Mesh Node

Press Search button below to find and adopt the new node into Mesh group.

### Backup Mesh Config

...

Available settings are explained as follows:

Item	Description
<b>General Setup</b>	
<b>Role</b>	<p><b>Mesh Root</b> – When VigorAP is connected to a Vigor router with a physical Ethernet cable, it can be set as mesh root to deliver the wireless signals to a mesh node AP.</p> <p><b>Mesh Node</b> – As a mesh node, such VigorAP can pass the wireless connection signal to other mesh node or a remote device (PC, CPE, mobile phone).</p> <p>In addition, VigorAP can be searched by mesh root AP and join the mesh group of the root AP. The configuration set for mesh root can be applied to mesh node.</p> <p><b>Log Level</b> – Choose <b>Basic</b> or <b>Detailed</b>. Related information will be shown on the <b>Diagnostics&gt;&gt;System Log</b>.</p>

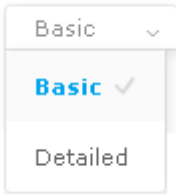

											
<p><b>When Mesh Root is selected</b></p>	<p><b>Wireless Downlink Band</b> – Choose a wireless band for connecting with a downlink mesh root or a downlink mesh node.</p> <p><b>Group Name</b> - Display the name of the current mesh group.</p> <p><b>Auto Reselect</b> - It is selected in default. To perform the auto reselect, make sure the process for CFG Sync and CFG Check for mesh nodes are successful. If enabled, after changing the environment of mesh network (e.g., offline, disconnection), the root device will perform auto reselect to reconstruct the mesh network.</p>										
<p><b>When Mesh Node is selected</b></p>	<p><b>Wired Uplink</b> – Check the box if such VigorAP connects to an uplink mesh root or an uplink mesh node with an Ethernet cable.</p> <p><b>Wireless Uplink/Downlink Band</b> – Choose a wireless band for connecting with an uplink/downlink mesh root or an uplink/downlink mesh node.</p>										
<p><b>Mesh Group</b></p>	<p>When the VigorAP is set as mesh root or is added to a mesh group, the basic information including role, MAC address, and model name of the AP will be shown in this area.</p> <p>Up to 8 entries (one mesh root and seven mesh nodes) will be shown on this field.</p> <p><b>Reset</b> - Click it to clear the Mesh Group information.</p> <p><b>Delete</b> - Click it to remove the selected entry.</p>										
<p><b>Add Mesh Node</b></p>	<p>Click <b>Search</b> to find out available mesh node on the network.</p> <div data-bbox="652 1258 1406 1476" data-label="Form"> <p><b>Add Mesh Node</b></p> <p>Press Search button below to find and adopt the new node into Mesh group.</p> <p><input type="button" value="Search"/></p> <p><b>Search List</b></p> <table border="1"> <thead> <tr> <th>Select</th> <th>MAC Address</th> <th>Model</th> <th>Operation Mode</th> <th>Device Name</th> </tr> </thead> <tbody> <tr> <td><input type="checkbox"/></td> <td>00:1D:AA:22:33:08</td> <td>VigorAP903</td> <td>MeshNode(Wireless)</td> <td><input type="text"/></td> </tr> </tbody> </table> <p><input type="button" value="Apply"/></p> </div> <p>Check the one you want and click <b>Apply</b>. The selected AP will be added onto current mesh root.</p>	Select	MAC Address	Model	Operation Mode	Device Name	<input type="checkbox"/>	00:1D:AA:22:33:08	VigorAP903	MeshNode(Wireless)	<input type="text"/>
Select	MAC Address	Model	Operation Mode	Device Name							
<input type="checkbox"/>	00:1D:AA:22:33:08	VigorAP903	MeshNode(Wireless)	<input type="text"/>							
<p><b>Backup Mesh Config</b></p>	<p><b>Backup</b> – Click the button to save the configuration as a file.</p> <p><b>Upload/Restore</b> – Click the Upload button to specify a configuration file. Then click Restore to apply the configuration.</p> <p>When the MAC address of such VigorAP does not appear under the mesh group, the restore operation will not succeed and the error message, "Device MAC is not in mesh group list", will be shown instead.</p>										

## How to set up a mesh group?

The following steps will guide you how to setup a Mesh Group (with mesh root and mesh node) from **Mesh >> Mesh Setup**.

1. Open **Mesh>>Mesh Setup**. Click **Mesh Root** and click **OK** for the VigorAP connected to PC with Ethernet cable. At first, a Mesh Group is with only Mesh Root.

### Mesh >> Mesh Setup

#### General Setup

Role	<input checked="" type="radio"/> Mesh Root <input type="radio"/> Mesh Node						
Wireless Downlink Band	Auto						
Group Name	VigorMesh						
Auto Reselect	<input checked="" type="checkbox"/>						
Log Level	Detailed						
<b>Mesh Group</b>							
Select	Index	Role	MAC Address	Model	CFG Sync	CFG Check	Device Name
	1	Root	00:1D:AA:04:F2:C8	VigorAP1000C			
<input type="button" value="Reset"/>							

<input checked="" type="button" value="OK"/>	<input type="button" value="Cancel"/>
--	---------------------------------------

#### Add Mesh Node

Press Search button below to find and adopt the new node into Mesh group.

<input type="button" value="Search"/>
---------------------------------------

#### Backup Mesh Config

<input type="button" value="Backup"/>	<input type="button" value="Browse"/>	<input type="text" value="..."/>	<input checked="" type="button" value="Restore"/>
---------------------------------------	---------------------------------------	----------------------------------	---

2. Click the **Search** button in the field of **Add Mesh Node**.

**Mesh Group**

Select	Index	Role	MAC Address	Model
	1	Root	00:1D:AA:04:F2:C8	VigorAP1000C

Reset

OK

Cancel

**Add Mesh Node**

Press Search button below to find and adopt the new node into Mesh group.

Search 

**Backup Mesh Config**

Backup Upload ... Restore

- Wait until the searching result appears.

**Add Mesh Node**

Press Search button below to find and adopt the new node into Mesh group.

Search

**Search List**

Select	MAC Address	Model	Operation Mode	Device Name
<input type="checkbox"/>	00:50:7F:F1:7E:EA	VigorAP903	MeshNode(Wireless)	<input type="text"/>
<input type="checkbox"/>	00:1D:AA:04:F0:10	VigorAP1000C	MeshNode(Wireless)	<input type="text"/>
<input type="checkbox"/>	00:1D:AA:32:BC:24	VigorAP920RPD	MeshNode(Wired)	<input type="text"/>
<input type="checkbox"/>	00:1D:AA:78:C9:20	VigorAP920R	MeshNode(Wireless)	<input type="text"/>
<input type="checkbox"/>	00:1D:AA:78:CF:BD	VigorAP920R	MeshNode(Wireless)	<input type="text"/>
<input type="checkbox"/>	00:1D:AA:68:D6:18	VigorAP920RPD	MeshNode(Wired)	<input type="text"/>

Apply

**Backup Mesh Config**

Backup Upload ... Restore

- Choose the device(s) you want to add to the Mesh Group as mesh node(s) and define the **Device Name** for each node. In this example, five devices are specified as mesh nodes.

**Add Mesh Node**

Press Search button below to find and adopt the new node into Mesh group.

Search

**Search List**

Select	MAC Address	Model	Operation Mode	Device Name
<input checked="" type="checkbox"/>	00:50:7F:F1:7E:EA	VigorAP903	MeshNode(Wireless)	room1
<input checked="" type="checkbox"/>	00:1D:AA:04:F0:10	VigorAP1000C	MeshNode(Wireless)	room2
<input type="checkbox"/>	00:1D:AA:32:BC:24	VigorAP920RPD	MeshNode(Wired)	
<input checked="" type="checkbox"/>	00:1D:AA:78:C9:20	VigorAP920R	MeshNode(Wireless)	room3
<input checked="" type="checkbox"/>	00:1D:AA:78:CF:B0	VigorAP920R	MeshNode(Wireless)	room4
<input checked="" type="checkbox"/>	00:1D:AA:68:D6:18	VigorAP920RPD	MeshNode(Wired)	room5

Apply

**Backup Mesh Config**

Backup Upload ... Restore

- Click the **Apply** button and wait for it to finish the procedure.

**Add Mesh Node**

Press Search button below to find and adopt the new node into Mesh group.

Search

**Search List**

Select	MAC Address	Model	Operation Mode	Device Name
<input checked="" type="checkbox"/>	00:50:7F:F1:7E:EA	VigorAP903	MeshNode(Wireless)	room1
<input checked="" type="checkbox"/>	00:1D:AA:04:F0:10	VigorAP1000C	MeshNode(Wireless)	room2
<input type="checkbox"/>	00:1D:AA:32:BC:24	VigorAP920RPD	MeshNode(Wired)	
<input checked="" type="checkbox"/>	00:1D:AA:78:C9:20	VigorAP920R	MeshNode(Wireless)	room3
<input checked="" type="checkbox"/>	00:1D:AA:78:CF:B0	VigorAP920R	MeshNode(Wireless)	room4
<input checked="" type="checkbox"/>	00:1D:AA:68:D6:18	VigorAP920RPD	MeshNode(Wired)	room5

Apply 

**Backup Mesh Config**

Backup Upload ... Restore

- After finishing the mesh network configuration, refer to **Mesh>>Mesh Status** for viewing the result. A mesh root with 5 mesh nodes is online.

Mesh >> Mesh Status

Local Status | Refresh |

Device Name	VigorAP 1000C	
MAC Address	00:1D:AA:04:F2:C8	
Model	VigorAP 1000C	
Operation Mode	MeshRoot	
Link Status	Connected	
Hop	0	
Downlink Number	5	
Downlink	00:1D:AA:04:F0:10 (VigorAP1000C)	Wireless 5GHz (Ch36) (-38dBm)
	00:1D:AA:78:CF:B0 (VigorAP920R)	Wireless 5GHz (Ch36) (-74dBm)
	00:1D:AA:68:D6:18 (VigorAP920RPD)	Ethernet
	00:1D:AA:78:C9:20 (VigorAP920R)	Wireless 5GHz (Ch36) (-54dBm)
	00:50:7F:F1:7E:EA (VigorAP903)	Wireless 5GHz (Ch36) (-33dBm)

Devices

Total number of Clients: 0

Index	Status	Device Name	IP Address	MAC Address (Model)	Hop	Uplink	Uptime	Clients
1	● Root	VigorAP1000C	172.17.3.97	00:1D:AA:04:F2:C8 (VigorAP1000C)	0		0d 01:16:17	0
2	● Online	room1	172.17.3.12	00:50:7F:F1:7E:EA (VigorAP903)	1	00:50:7F:F1:7E:ED Wireless 5GHz (Ch36) (-30dBm)	0d 00:21:43	0
3	● Online	room2	172.17.3.8	00:1D:AA:04:F0:10 (VigorAP1000C)	1	00:50:7F:F1:7E:ED Wireless 5GHz (Ch36) (-40dBm)	0d 00:44:50	0
4	● Online	room3	172.17.3.6	00:1D:AA:78:C9:20 (VigorAP920R)	1	00:50:7F:F1:7E:ED Wireless 5GHz (Ch36) (-47dBm)	0d 01:01:46	0
5	● Online	room4	172.17.3.98	00:1D:AA:78:CF:B0 (VigorAP920R)	1	00:50:7F:F1:7E:ED Wireless 5GHz (Ch36) (-64dBm)	0d 01:02:01	0
6	● Online	room5	172.17.3.10	00:1D:AA:68:D6:18 (VigorAP920RPD)	0	00:50:7F:F1:7E:ED Ethernet	0d 01:03:05	0

● Online(sync ready) ● Online ● Offline

Last updated: 18:40:51 2020

## II-4-2 Mesh Status

This page shows that one Mesh Group can contain up to 8 devices. In the following figure, the 7th Device with hop 0 is one special Ethernet Backhaul. It means this node will use Ethernet cable to join the mesh group while others use the wireless link.

Mesh >> Mesh Status

Local Status		Refresh							
Device Name	VigorAP1000C								
MAC Address	00:1D:AA:04:F2:C8								
Model	VigorAP1000C								
Operation Mode	MeshRoot								
Group Name	VigorMesh								
Link Status	Connected								
Hop	0								
Downlink Number	0								
Devices		Total number of Clients: 0							
Index	Status	Device Name	IP Address	MAC Address (Model)	Hop	Uplink	Uptime	Clients	Speed Test
1	● Root	VigorAP100...	192.168.1.11	00:1D:AA:04:F2:C8 (VigorAP1000C)	0	0d	03:13:02	0	
● Online(sync ready)		● Online	● Offline	Last updated: Thu Feb 27 17:08:22 2020					

Item	Description																																																																																																																																																																																													
<b>Local Status</b>	Display general information for such VigorAP.																																																																																																																																																																																													
<b>Devices</b>	<p>Display detailed information for this VigorAP (as mesh root) and mesh node(s) in the group.</p> <p><b>Index</b> – Display the number of the device within a mesh group.</p> <p><b>Status</b> – Display the role of the device within a mesh group.</p> <p><b>Device Name</b> – Display the name of the device (for identification).</p> <p><b>IP Address</b> – Display the IP address of the device.</p> <p><b>MAC Address</b> – Display the MAC address of the device.</p> <p><b>Hop</b> – Display the level of the devices within a mesh group. "0" means the access point is connected to a device by using Ethernet cable (wired). "1" to "3" means the level of the access point within a mesh group and it connects to other access point via wireless link.</p> <p><b>Uplink</b> – Display the MAC address of the device that the AP connects to.</p>																																																																																																																																																																																													
<b>Total number of Clients</b>	<p>Display the station list of all mesh devices.</p> <table border="1"> <thead> <tr> <th>Index</th> <th>MAC Address</th> <th>Hostname</th> <th>Vendor</th> <th>SSID</th> <th>Channel</th> <th>RSSI</th> <th>TxRate(Kbps)</th> <th>RxRate(Kbps)</th> </tr> </thead> <tbody> <tr><td>1</td><td>00:50:7F:F0:C9:72</td><td>TA001029</td><td>DrayTek</td><td>staffs_4F</td><td>6</td><td>68%(-63dBm)</td><td>0</td><td>0</td></tr> <tr><td>2</td><td>00:50:7F:F0:D1:1D</td><td>ta002171</td><td>DrayTek</td><td>staffs_4F</td><td>6</td><td>41%(-73dBm)</td><td>0</td><td>0</td></tr> <tr><td>3</td><td>5C:97:F3:D3:D5:F7</td><td>Tze-Pingde...</td><td>Apple</td><td>staffs_4F</td><td>6</td><td>100%(-49dBm)</td><td>0</td><td>0</td></tr> <tr><td>4</td><td>40:98:AD:5B:F2:52</td><td>Tyronetkii...</td><td>Apple</td><td>staffs</td><td>6</td><td>55%(-68dBm)</td><td>0</td><td>0</td></tr> <tr><td>5</td><td>00:50:7F:37:6D:E5</td><td>N/A</td><td>DrayTek</td><td>staffs_4F</td><td>6</td><td>52%(-69dBm)</td><td>0</td><td>0</td></tr> <tr><td>6</td><td>00:50:7F:37:67:BE</td><td>N/A</td><td>DrayTek</td><td>staffs_4F</td><td>6</td><td>55%(-68dBm)</td><td>0</td><td>0</td></tr> <tr><td>7</td><td>30:F7:C5:1D:3D:11</td><td>N/A</td><td>Apple</td><td>guests</td><td>6</td><td>83%(-57dBm)</td><td>30</td><td>12</td></tr> <tr><td>8</td><td>40:F0:2F:22:EB:A0</td><td>N/A</td><td>LiteonTe</td><td>staffs</td><td>6</td><td>34%(-76dBm)</td><td>22</td><td>4</td></tr> <tr><td>9</td><td>18:65:90:DE:D4:E5</td><td>N/A</td><td>Apple</td><td>staffs_4F</td><td>6</td><td>100%(-44dBm)</td><td>0</td><td>0</td></tr> <tr><td>10</td><td>60:45:CB:57:1F:36</td><td>N/A</td><td>N/A</td><td>staffs_4F</td><td>6</td><td>15%(-84dBm)</td><td>0</td><td>0</td></tr> <tr><td>11</td><td>AC:5F:3E:62:E6:0D</td><td>N/A</td><td>Samsung</td><td>staffs_4F</td><td>6</td><td>81%(-58dBm)</td><td>0</td><td>0</td></tr> <tr><td>12</td><td>50:BC:96:E0:00:11</td><td>N/A</td><td>Apple</td><td>staffs</td><td>6</td><td>71%(-62dBm)</td><td>0</td><td>0</td></tr> <tr><td>13</td><td>04:B1:67:52:48:90</td><td>Redmi5-mys...</td><td>N/A</td><td>staffs_4F</td><td>6</td><td>45%(-72dBm)</td><td>0</td><td>0</td></tr> <tr><td>14</td><td>04:C2:3E:3F:CB:F8</td><td>android-ac...</td><td>HTC</td><td>staffs_4F</td><td>6</td><td>55%(-68dBm)</td><td>0</td><td>0</td></tr> <tr><td>15</td><td>0C:8B:FD:31:0B:78</td><td>N/A</td><td>Intel</td><td>staffs_4F</td><td>6</td><td>89%(-55dBm)</td><td>2</td><td>2</td></tr> <tr><td>16</td><td>58:48:22:EB:F8:62</td><td>android-Sf...</td><td>Sony</td><td>staffs</td><td>6</td><td>55%(-68dBm)</td><td>0</td><td>0</td></tr> <tr><td>17</td><td>CC:9F:7A:63:11:27</td><td>N/A</td><td>N/A</td><td>staffs_4F5...</td><td>36</td><td>52%(-69dBm)</td><td>0</td><td>0</td></tr> <tr><td>18</td><td>20:47:DA:58:17:79</td><td>RedmiNote5...</td><td>N/A</td><td>staffs_4F5...</td><td>36</td><td>50%(-70dBm)</td><td>0</td><td>0</td></tr> <tr><td>19</td><td>70:81:EB:65:80:E5</td><td>cheng</td><td>Apple</td><td>staffs_4F5...</td><td>36</td><td>87%(-56dBm)</td><td>0</td><td>0</td></tr> <tr><td>20</td><td>8C:85:90:64:FE:A4</td><td>N/A</td><td>Apple</td><td>staffs_4F5...</td><td>36</td><td>36%(-75dBm)</td><td>0</td><td>0</td></tr> </tbody> </table>	Index	MAC Address	Hostname	Vendor	SSID	Channel	RSSI	TxRate(Kbps)	RxRate(Kbps)	1	00:50:7F:F0:C9:72	TA001029	DrayTek	staffs_4F	6	68%(-63dBm)	0	0	2	00:50:7F:F0:D1:1D	ta002171	DrayTek	staffs_4F	6	41%(-73dBm)	0	0	3	5C:97:F3:D3:D5:F7	Tze-Pingde...	Apple	staffs_4F	6	100%(-49dBm)	0	0	4	40:98:AD:5B:F2:52	Tyronetkii...	Apple	staffs	6	55%(-68dBm)	0	0	5	00:50:7F:37:6D:E5	N/A	DrayTek	staffs_4F	6	52%(-69dBm)	0	0	6	00:50:7F:37:67:BE	N/A	DrayTek	staffs_4F	6	55%(-68dBm)	0	0	7	30:F7:C5:1D:3D:11	N/A	Apple	guests	6	83%(-57dBm)	30	12	8	40:F0:2F:22:EB:A0	N/A	LiteonTe	staffs	6	34%(-76dBm)	22	4	9	18:65:90:DE:D4:E5	N/A	Apple	staffs_4F	6	100%(-44dBm)	0	0	10	60:45:CB:57:1F:36	N/A	N/A	staffs_4F	6	15%(-84dBm)	0	0	11	AC:5F:3E:62:E6:0D	N/A	Samsung	staffs_4F	6	81%(-58dBm)	0	0	12	50:BC:96:E0:00:11	N/A	Apple	staffs	6	71%(-62dBm)	0	0	13	04:B1:67:52:48:90	Redmi5-mys...	N/A	staffs_4F	6	45%(-72dBm)	0	0	14	04:C2:3E:3F:CB:F8	android-ac...	HTC	staffs_4F	6	55%(-68dBm)	0	0	15	0C:8B:FD:31:0B:78	N/A	Intel	staffs_4F	6	89%(-55dBm)	2	2	16	58:48:22:EB:F8:62	android-Sf...	Sony	staffs	6	55%(-68dBm)	0	0	17	CC:9F:7A:63:11:27	N/A	N/A	staffs_4F5...	36	52%(-69dBm)	0	0	18	20:47:DA:58:17:79	RedmiNote5...	N/A	staffs_4F5...	36	50%(-70dBm)	0	0	19	70:81:EB:65:80:E5	cheng	Apple	staffs_4F5...	36	87%(-56dBm)	0	0	20	8C:85:90:64:FE:A4	N/A	Apple	staffs_4F5...	36	36%(-75dBm)	0	0
Index	MAC Address	Hostname	Vendor	SSID	Channel	RSSI	TxRate(Kbps)	RxRate(Kbps)																																																																																																																																																																																						
1	00:50:7F:F0:C9:72	TA001029	DrayTek	staffs_4F	6	68%(-63dBm)	0	0																																																																																																																																																																																						
2	00:50:7F:F0:D1:1D	ta002171	DrayTek	staffs_4F	6	41%(-73dBm)	0	0																																																																																																																																																																																						
3	5C:97:F3:D3:D5:F7	Tze-Pingde...	Apple	staffs_4F	6	100%(-49dBm)	0	0																																																																																																																																																																																						
4	40:98:AD:5B:F2:52	Tyronetkii...	Apple	staffs	6	55%(-68dBm)	0	0																																																																																																																																																																																						
5	00:50:7F:37:6D:E5	N/A	DrayTek	staffs_4F	6	52%(-69dBm)	0	0																																																																																																																																																																																						
6	00:50:7F:37:67:BE	N/A	DrayTek	staffs_4F	6	55%(-68dBm)	0	0																																																																																																																																																																																						
7	30:F7:C5:1D:3D:11	N/A	Apple	guests	6	83%(-57dBm)	30	12																																																																																																																																																																																						
8	40:F0:2F:22:EB:A0	N/A	LiteonTe	staffs	6	34%(-76dBm)	22	4																																																																																																																																																																																						
9	18:65:90:DE:D4:E5	N/A	Apple	staffs_4F	6	100%(-44dBm)	0	0																																																																																																																																																																																						
10	60:45:CB:57:1F:36	N/A	N/A	staffs_4F	6	15%(-84dBm)	0	0																																																																																																																																																																																						
11	AC:5F:3E:62:E6:0D	N/A	Samsung	staffs_4F	6	81%(-58dBm)	0	0																																																																																																																																																																																						
12	50:BC:96:E0:00:11	N/A	Apple	staffs	6	71%(-62dBm)	0	0																																																																																																																																																																																						
13	04:B1:67:52:48:90	Redmi5-mys...	N/A	staffs_4F	6	45%(-72dBm)	0	0																																																																																																																																																																																						
14	04:C2:3E:3F:CB:F8	android-ac...	HTC	staffs_4F	6	55%(-68dBm)	0	0																																																																																																																																																																																						
15	0C:8B:FD:31:0B:78	N/A	Intel	staffs_4F	6	89%(-55dBm)	2	2																																																																																																																																																																																						
16	58:48:22:EB:F8:62	android-Sf...	Sony	staffs	6	55%(-68dBm)	0	0																																																																																																																																																																																						
17	CC:9F:7A:63:11:27	N/A	N/A	staffs_4F5...	36	52%(-69dBm)	0	0																																																																																																																																																																																						
18	20:47:DA:58:17:79	RedmiNote5...	N/A	staffs_4F5...	36	50%(-70dBm)	0	0																																																																																																																																																																																						
19	70:81:EB:65:80:E5	cheng	Apple	staffs_4F5...	36	87%(-56dBm)	0	0																																																																																																																																																																																						
20	8C:85:90:64:FE:A4	N/A	Apple	staffs_4F5...	36	36%(-75dBm)	0	0																																																																																																																																																																																						

## II-4-3 Mesh Discovery

Before a Mesh Node is connected, it is unable to check the device status from Mesh Root. This page can help to discover all Mesh devices around and offer the Link Status and Operation Mode of each Mesh device.

**Mesh >> Mesh Discovery**

### Device List

Index	MAC Address	Model	Operation Mode	Link Status
1	00:50:7F:F1:7F:1D	VigorAP903	MeshNode(Wireless)	Connected
2	00:1D:AA:62:0F:E8	Vigor2862	MeshRoot	Connected
3	00:1D:AA:63:2C:00	VigorAP920R	MeshRoot	Connected
4	00:1D:AA:57:5D:38	VigorAP1000C	AP	
5	00:1D:AA:04:F0:D8	VigorAP1000C	MeshNode(Wireless)	Connected
6	00:1D:AA:04:F0:DC	VigorAP1000C	AP	
7	00:1D:AA:04:F0:6C	VigorAP1000C	MeshRoot	Connected
8	00:1D:AA:63:2C:10	VigorAP920RPD	MeshNode(Wireless)	Connected
9	00:50:7F:F1:7E:CB	VigorAP903	MeshRoot	Connected

Scan

**Note:** During the scanning process (about 10 seconds), no station is allowed to connect with the AP and Mesh Network may disconnect.

For obtaining the list of devices around this VigorAP, click **Scan**. Later, surrounding VigorAP device(s) will be displayed on this page.

## II-4-4 Basic Configuration Sync

If you add one Mesh Node in a mesh group, the Mesh Root will send the basic configuration to the device. This page could help you to change the Mesh Root settings and deliver the new configuration of the Mesh Root to all "connected" Mesh Nodes.

Mesh >> Basic Configuration Sync

Select All

System Maintenance

Index	Name	Value
1	ManagementServer.URL	
2	ManagementServer.Username	
3	ManagementServer.Password	*****
4	ManagementServer.ConnectionRequestUsername	vigor
5	ManagementServer.ConnectionRequestPassword	*****
6	ManagementServer.PeriodicInformEnable	1
7	ManagementServer.PeriodicInformInterval	900
8	X_00507F_System.Management.SkipQuickStartWizard	Enable
9	X_00507F_System.TR069Setting.CPEEnable	0
10	X_00507F_System.AdminmodePassword.Admin	admin
11	X_00507F_System.SyslogMail.SysLogAccess.SysLogEnable	0
12	X_00507F_System.SyslogMail.SysLogAccess.LogServerIP	
13	X_00507F_System.SyslogMail.SysLogAccess.LogServerPort	514
14	X_00507F_System.SyslogMail.SysLogAccess.LogLevel	
15	X_00507F_System.SyslogMail.MailAlert.MailAlertEnable	0
16	X_00507F_System.SyslogMail.MailAlert.SMTPServer	
17	X_00507F_System.SyslogMail.MailAlert.MailTo	
18	X_00507F_System.SyslogMail.MailAlert.MailFrom	

Available settings are explained as follows:

Item	Description
<b>System Maintenance / Wireless LAN (2.4Hz) / Wireless LAN (5GHz) Wireless LAN (5GHz-2)</b>	Check the item(s) you want to make configuration sync. <b>Apply</b> – Click it to apply the settings configured by such AP to all connected mesh node. <b>Note that this button is available only when such AP is in mesh root mode.</b>

### Tips for Mesh Network Setup

- Set up TWO mesh devices with uplink RSSI larger than -65dBm.
- Upgrade the firmware version of Mesh devices through Mesh link, starting from the mesh device with less hop number. For example, upgrade the firmware from the root, hop1 Mesh Node then hop2 Mesh Node, and so on.
- VigorMesh network supports up to 3 hops of mesh devices. However, it is suggested to connect the mesh group with less than or equals to 2 hops.

For your reference, we make a real mesh environment test and get the following record. (Use VigorAP APP to do internet speed test with different hops mesh node.)

Internet Download Speed (for root and hop1 ~ hop3):

iPad connects to Root : 80Mbps

iPad connects to hop1 Node : 49Mbps (Uplink RSSI : -55dBm)

iPad connects to hop2 Node : 41Mbps (Uplink RSSI : hop2 -64dBm / hop1 -55dBm)

iPad connects to hop3 Node : 26Mbps (Uplink RSSI : hop3 -62dBm / hop2 -68dBm / hop1 -55dBm)

- It is not suggested to use a wireless Mesh Node with Ethernet cable connected to a Mesh Root.
- If resetting a Mesh Root,



- All "connected" Mesh Nodes will be informed to reset.
- Group List and Group Key will be reset, too.
- For those Mesh Nodes unable to reset, reset them manually. Reset the Group List by web or factory default.
- If resetting a Mesh Node,
  - Group List and Group Key will be cleared.
  - Link Status will become "New".
- Mesh network status also can be viewed and checked through the dashboard by clicking MESH NETWORK.

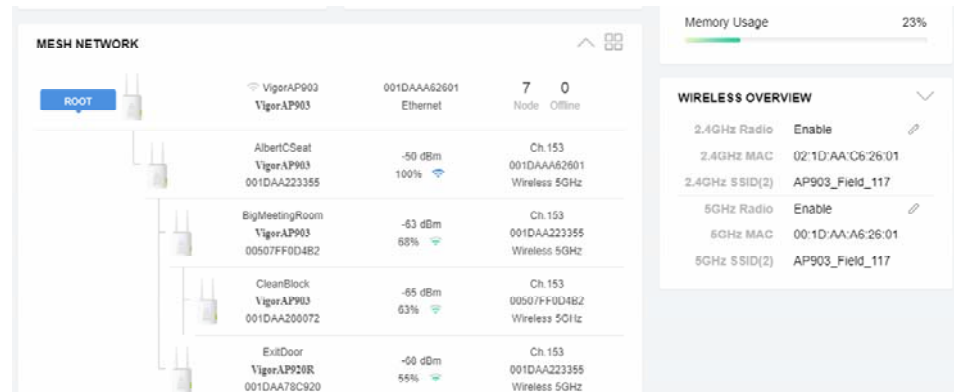

- If Mesh Search / Apply / Discover is worked too fast or is done with empty result, your request may be rejected. Please try again.
- Troubleshooting:
  - Check the firmware version. Please make sure all APs within the mesh group are in the newest firmware version.
  - Check the OP (operation) Mode. Make sure new Mesh Node doesn't accidentally get DHCP IP and becomes AP mode.
  - Check the country code and channels. For example, it is impossible for connecting a VigorAP 1000C Mesh Root with 5G channel 36 to VigorAP920R Wireless Mesh Node in EU country code.
  - Check the channel load. Make sure it is not over 70%.

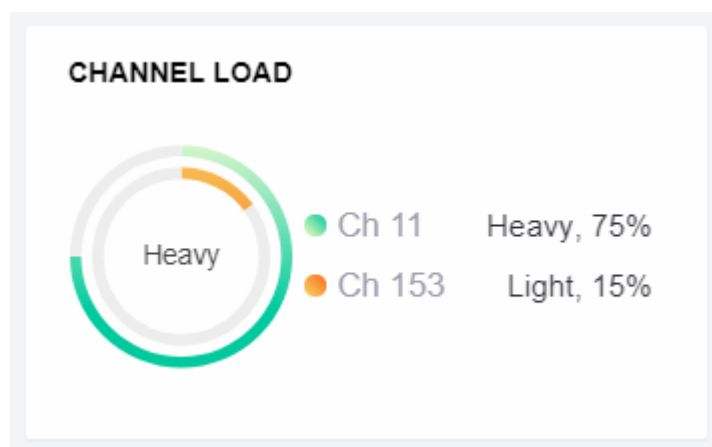

- Collect some Mesh logs and send the result to DrayTek for analyzing.

DrayTek Syslog 4.5.6

## DrayTek Syslog Utility

Log 過濾器

關鍵字:

表用至: All

172.17.3.6

AP920R

LAN 資訊

傳送封包 接收封包

9756 47236

WAN 資訊

傳送速率 接收速率

WAN1

WAN IP (固定) 網速 IP (固定)

APP: Mesh 使用者存取紀錄 Channel Roaming Wireless 其他

暫停

系統時間	路由器時間	主機	訊息
2018-11-08 19:01:16	Nov 8 10:58:05	syslog	[dnn] dnn_pkt_recv Announce-Keepalive
2018-11-08 19:01:15	Nov 8 10:58:04	syslog	[dnn] dnn_pkt_send Alive
2018-11-08 19:01:04	Nov 8 10:57:52	syslog	[dnn] dnn_pkt_send Alive
2018-11-08 19:01:01	Nov 8 10:57:50	syslog	[dnn] dnn_pkt_recv Announce-Keepalive
2018-11-08 19:00:59	Nov 8 10:57:48	kernel	[7525.325564][dnn] Mesh IE Record (Isolate) 00:1D-AA:5C:A6:C8
2018-11-08 19:00:53	Nov 8 10:57:41	syslog	[dnn] dnn_pkt_send Alive
2018-11-08 19:00:47	Nov 8 10:57:36	syslog	[dnn] dnn_pkt_recv Announce-Keepalive
2018-11-08 19:00:41	Nov 8 10:57:30	syslog	[dnn] dnn_pkt_send Alive
2018-11-08 19:00:39	Nov 8 10:57:28	kernel	[7505.200014][dnn] Mesh IE Record (Isolate) 00:1D-AA:5C:A6:C8
2018-11-08 19:00:33	Nov 8 10:57:22	syslog	[dnn] dnn_pkt_recv Announce-Keepalive
2018-11-08 19:00:30	Nov 8 10:57:19	syslog	[dnn] dnn_pkt_send Alive
2018-11-08 19:00:19	Nov 8 10:57:08	syslog	[dnn] dnn_pkt_send Alive
2018-11-08 19:00:18	Nov 8 10:57:07	syslog	[dnn] dnn_pkt_recv Announce-Keepalive
2018-11-08 19:00:07	Nov 8 10:56:56	syslog	[dnn] dnn_pkt_send Alive

## II-4-5 Advanced Config Sync

If you add one Mesh Node in a mesh group, the Mesh Root will synchronize the advanced configuration to the device based on the setting results on this page.

Mesh >> Advanced Configuration Sync

Select All

Bridge VLAN to Mesh

Index	Name	Value
1	X_00507F_LAN.GeneralSetup.BridgeVLANtoWDS	Enable

Roaming

Index	Name	Value
1	X_00507F_WirelessLAN_AP.Roaming.APAClientRoaming.EnMinBasicRate	0
2	X_00507F_WirelessLAN_AP.Roaming.APAClientRoaming.MinBasicRate	1Mbps
3	X_00507F_WirelessLAN_AP.Roaming.APAClientRoaming.RSSI	Disable_RSSI_Requirement
4	X_00507F_WirelessLAN_AP.Roaming.APAClientRoaming.StrictlyRSSISignal	73
5	X_00507F_WirelessLAN_AP.Roaming.APAClientRoaming.MinRSSISignal	66
6	X_00507F_WirelessLAN_AP.Roaming.APAClientRoaming.AdjacentRSSISignal	5
7	X_00507F_WirelessLAN_AP.Roaming.FastRoaming.Enable	0
8	X_00507F_WirelessLAN_AP.Roaming.FastRoaming.CachePeriod	10
9	X_00507F_WirelessLAN_AP.Roaming.FastTransitionRoaming.Enable	0
10	X_00507F_WirelessLAN_AP.Roaming.FastTransitionRoaming.DsOrAir	1
11	X_00507F_WirelessLAN_5G_AP.Roaming.APAClientRoaming.EnMinBasicRate	0
12	X_00507F_WirelessLAN_5G_AP.Roaming.APAClientRoaming.MinBasicRate	6Mbps
13	X_00507F_WirelessLAN_5G_AP.Roaming.APAClientRoaming.RSSI	Disable_RSSI_Requirement
14	X_00507F_WirelessLAN_5G_AP.Roaming.APAClientRoaming.StrictlyRSSISignal	73
15	X_00507F_WirelessLAN_5G_AP.Roaming.APAClientRoaming.MinRSSISignal	66
16	X_00507F_WirelessLAN_5G_AP.Roaming.APAClientRoaming.AdjacentRSSISignal	5
17	X_00507F_WirelessLAN_5G_AP.Roaming.FastRoaming.Enable	0
18	X_00507F_WirelessLAN_5G_AP.Roaming.FastRoaming.CachePeriod	10

Available settings are explained as follows:

Item	Description
Select All	All item(s) will be selected for making configuration sync.
Bridge VLAN to Mesh	Check to transmit the packets with VLAN tag to mesh nodes.

## II-4-6 Support List

Mesh >> Support List

The following compatibility test lists Draytek AP models supported by this AP Mesh.

Model	Status	Firmware Version
VigorAP 802	Y	1.3.4.1
VigorAP 903	Y	1.3.7
VigorAP 912C	Y	1.3.5
VigorAP 920C	Y	1.3.4
VigorAP 960C	Y	1.3.9
VigorAP 1000C	Y	1.3.4
VigorAP 1060C	Y	1.3.8

Y:Tested and is supported.

N:Not supported.

## II-4-7 Mesh Syslog

Mesh >> Mesh Syslog

Mesh Log Information

| [Clear](#) | [Refresh](#) |  Line wrap |

```
Oct 6 10:54:37 : [dmn] dmn_pkt_send Clone-v2
Oct 6 10:54:37 : [dmn] dmn_pkt_send Clone
Oct 6 10:54:37 : [dmn] dmn_pkt_send Clone-v2
Oct 6 10:54:37 : [dmn] dmn_pkt_send Clone
Oct 6 10:54:38 : [dmn] dmn_pkt_send Clone-v2
Oct 6 10:54:38 : [dmn] dmn_pkt_send Clone
Oct 6 10:54:39 : [dmn] dmn_pkt_send Clone-v2
Oct 6 10:54:39 : [dmn] dmn_pkt_send Clone
Oct 6 10:54:39 : [dmn] dmn_pkt_send Clone-v2
Oct 6 10:54:39 : [dmn] dmn_pkt_send Clone
Oct 6 10:54:40 : [dmn] dmn_pkt_send Clone-v2
Oct 6 10:54:40 : [dmn] dmn_pkt_send Clone
Oct 6 10:54:41 : [dmn] dmn_pkt_send Clone-v2
Oct 6 10:54:41 : [dmn] dmn_pkt_send Clone
Oct 6 10:54:41 : [dmn] dmn_pkt_send Clone-v2
Oct 6 10:54:41 : [dmn] dmn_pkt_send Clone
Oct 6 10:54:42 : [dmn] dmn_pkt_send Clone-v2
```

## II-5 Universal Repeater Settings for Range Extender Mode

When you choose **Range Extender** as the operation mode, the Wireless LAN menu items (for 2.4GHz and 5GHz/5GHz-2) will include General Setup, Security, Access Control, WPS, Advanced Setting, AP Discovery, WDS AP Status, Universal Repeater, Bandwidth Management, Airtime Fairness, Station Control, Roaming, Band Steering and Station List.

This section will introduce settings for Universal Repeater only.

For other wireless setting items (e.g., General Setup, Security, WPS, and etc.), please refer to II-3.

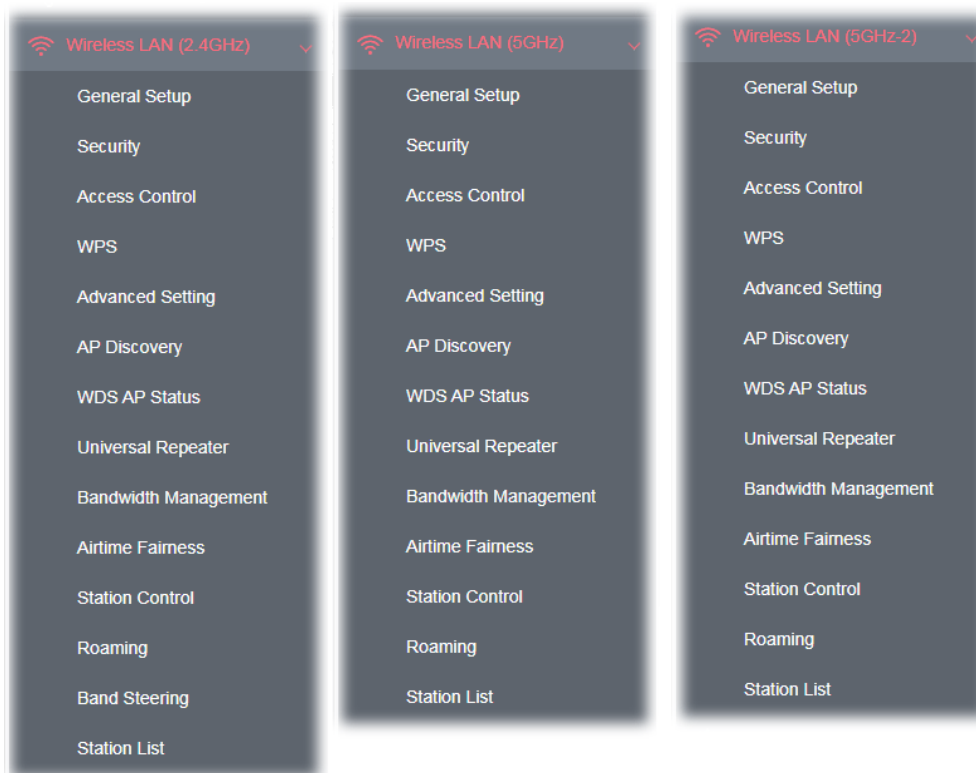

The following figure shows how VigorAP runs as Range Extender:



The access point can act as a wireless repeater; it can be Station and AP at the same time. It can use Station function to connect to a root AP and use AP function to serve all wireless stations within its coverage.

**i** Note:

While using **Universal Repeater** mode, the access point will demodulate the received signal. Please check if this signal is noise for the operating network, then have the signal modulated and amplified again. The output power of this mode is the same as that of AP mode.

Wireless LAN (2.4GHz) >> Universal Repeater

Universal Repeater Parameters

SSID	<input type="text"/>
MAC Address (Optional)	<input type="text"/>
Channel	2462MHz (Channel 11) ▾
Security Mode	WPA2/PSK ▾
Encryption Type	AES ▾
Pass Phrase	<input type="text"/>
Range Extender Band	None

**Note:** If Channel is modified, the Channel setting of AP would also be changed.

Universal Repeater IP Configuration

Connection Type	DHCP ▾
Device Name	AP1000C <input type="text"/>

Available settings are explained as follows:

Item	Description
<b>Universal Repeater Parameters</b>	
<b>SSID</b>	Display the SSID defined for Range Extender operation mode in Quick Start Wizard. Change the name of SSID whenever you want.
<b>MAC Address (Optional)</b>	Type the MAC address of access point that VigorAP 1000C wants to connect to.
<b>Channel</b>	Means the channel of frequency of the wireless LAN. As a tri-band access point, VigorAP offers different channels for WLAN 2.4GHz, 5GHZ and 5GHZ-2 respectively. You may switch channel if the selected channel is under serious interference. If you have no idea of choosing the frequency, please select <b>AutoSelect</b> to let system determine for you.
<b>Security Mode</b>	There are several modes provided for you to choose. Each mode will

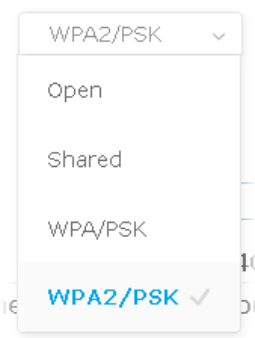
	<p>bring up different parameters (e.g., WEP keys, Pass Phrase) for you to configure.</p> 
<b>Encryption Type for Open/Shared</b>	<p>This option is available when Open/Shared is selected as Security Mode.</p> <p>Choose <b>None</b> to disable the WEP Encryption. Data sent to the AP will not be encrypted. To enable WEP encryption for data transmission, please choose <b>WEP</b>.</p> <p><b>WEP Keys</b> - Four keys can be entered here, but only one key can be selected at a time. The format of WEP Key is restricted to 5 ASCII characters or 10 hexadecimal values in 64-bit encryption level, or restricted to 13 ASCII characters or 26 hexadecimal values in 128-bit encryption level. The allowed content is the ASCII characters from 33(!) to 126(~) except '#' and ','.</p>
<b>Encryption Type for WPA/PSK and WPA2/PSK</b>	<p>This option is available when WPA/PSK or WPA2/PSK is selected as <b>Security Mode</b>.</p> <p>Select <b>TKIP</b> or <b>AES</b> as the algorithm for WPA.</p>
<b>Pass Phrase</b>	<p>Type <b>8~63</b> ASCII characters, such as 012345678 (or 64 Hexadecimal digits leading by 0x, such as "0x321253abcde...").</p>
<b>Range Extender Band</b>	<p>Display which wireless band (2.4G/5G) is currently used for Universal Repeater.</p> <p><b>None</b> - No network connection.</p>
<b>Universal Repeater IP Configuration</b>	
<b>Connection Type</b>	<p>Choose DHCP or Static IP as the connection mode.</p> <p><b>DHCP</b> - The wireless station will be assigned with an IP from VigorAP.</p> <p><b>Static IP</b> - The wireless station shall specify a static IP for connecting to Internet via VigorAP.</p>
<b>Device Name</b>	<p>This setting is available when <b>DHCP</b> is selected as <b>Connection Type</b>.</p> <p>Type a name for the VigorAP as identification. Simply use the default name.</p>
<b>IP Address</b>	<p>This setting is available when <b>Static IP</b> is selected as <b>Connection Type</b>.</p> <p>Type an IP address with the same network segment of the LAN IP setting of VigorAP. Such IP shall be different with any IP address in LAN.</p>
<b>Subnet Mask</b>	<p>This setting is available when <b>Static IP</b> is selected as <b>Connection Type</b>.</p> <p>Type the subnet mask setting which shall be the same as the one configured in LAN for VigorAP.</p>

---

<b>Default Gateway</b>	This setting is available when <b>Static IP</b> is selected as <b>Connection Type</b> . Type the gateway setting which shall be the same as the default gateway configured in LAN for VigorAP.
------------------------	---

---

After finishing this web page configuration, please click **OK** to save the settings.



# II-6 LAN

Local Area Network (LAN) is a group of subnets regulated and ruled by modem.



## II-6-1 General Setup

Click **LAN** to open the LAN settings page and choose **General Setup**.

**Note:**

Such page will be changed according to the Operation Mode selected. The following screen is obtained by choosing AP as the operation mode.

LAN >> General Setup

Ethernet TCP / IP and DHCP Setup

<b>LAN IP Network Configuration</b> <input checked="" type="checkbox"/> Enable DHCP Client IP Address: 192.168.1.11 Subnet Mask: 255.255.255.0  <input type="checkbox"/> Enable Management VLAN VLAN ID: 0	<b>DHCP Server Configuration</b> <input type="radio"/> Enable Server <input checked="" type="radio"/> Disable Server <input type="radio"/> Relay Agent WLAN Trusted DHCP Server: Server IP Address
<b>DNS Server IP Address</b> Primary IP Address: <input type="text"/> Secondary IP Address: <input type="text"/>	

OK Cancel

Available settings are explained as follows:

Item	Description
LAN IP Network	<b>Enable DHCP Client</b> - When it is enabled, VigorAP 1000C will be treated as a client and can be managed / controlled by AP

<p><b>Configuration</b></p>	<p>Management server offered by Vigor router (e.g., Vigor2865).</p> <ul style="list-style-type: none"> <li>● <b>IP Address</b> – Type in private IP address for connecting to a local private network (Default: 192.168.1.2).</li> <li>● <b>Subnet Mask</b> – Type in an address code that determines the size of the network. (Default: 255.255.255.0/ 24)</li> </ul> <p><b>Enable Management VLAN</b> – VigorAP 1000C supports tag-based VLAN for wireless clients accessing Vigor device. Only the clients with the specified VLAN ID can access into VigorAP 1000C.</p> <ul style="list-style-type: none"> <li>● <b>VLAN ID</b> – Type the number as VLAN ID tagged on the transmitted packet. “0” means no VALN tag.</li> </ul>
<p><b>DHCP Server Configuration</b></p>	<p>DHCP stands for Dynamic Host Configuration Protocol. DHCP server can automatically dispatch related IP settings to any local user configured as a DHCP client.</p> <p><b>Enable Server</b> - Enable Server lets the modem assign IP address to every host in the LAN.</p> <ul style="list-style-type: none"> <li>● <b>Start IP Address</b> - Enter a value of the IP address pool for the DHCP server to start with when issuing IP addresses. If the 1st IP address of your modem is 192.168.1.2, the starting IP address must be 192.168.1.3 or greater, but smaller than 192.168.1.254.</li> <li>● <b>End IP Address</b> - Enter a value of the IP address pool for the DHCP server to end with when issuing IP addresses.</li> <li>● <b>Subnet Mask</b> - Type in an address code that determines the size of the network. (Default: 255.255.255.0/ 24)</li> <li>● <b>Default Gateway</b> - Enter a value of the gateway IP address for the DHCP server.</li> <li>● <b>Lease Time</b> - It allows you to set the leased time for the specified PC.</li> <li>● <b>Primary DNS Server</b> - You must specify a DNS server IP address here because your ISP should provide you with usually more than one DNS Server. If your ISP does not provide it, the modem will automatically apply default DNS Server IP address: 194.109.6.66 to this field.</li> <li>● <b>Secondary DNS Server</b> - You can specify secondary DNS server IP address here because your ISP often provides you more than one DNS Server. If your ISP does not provide it, the modem will automatically apply default secondary DNS Server IP address: 194.98.0.1 to this field.</li> </ul> <p><b>Relay Agent</b> - Specify which subnet that DHCP server is located the relay agent should redirect the DHCP request to.</p> <ul style="list-style-type: none"> <li>● <b>DHCP Relay Agent</b> - It is available when Enable Relay Agent is selected. Set the IP address of the DHCP server you are going to use so the Relay Agent can help to forward the DHCP request to the DHCP server.</li> </ul> <p><b>Disable Server</b> - Disable Server lets you manually or use other DHCP server to assign IP address to every host in the LAN.</p> <ul style="list-style-type: none"> <li>● <b>WLAN Trusted DHCP Server</b> –There is no right for such VigorAP to assign IP address for wireless LAN user. However, you can specify another valid DHCP server on other VigorAP to make the wireless LAN client obtaining the IP address from the designated</li> </ul>

	<p>DHCP server.</p> <p>Specify a DHCP server in such field. All the IP addresses of the devices on LAN of VigorAP will be assigned via such specified server. It is used to avoid IP assignment interference due to multiple DHCP servers in one LAN.</p>
<b>DNS Server IP Address</b>	<p><b>Primary DNS Server</b> - You must specify a DNS server IP address here because your ISP should provide you with usually more than one DNS Server. If your ISP does not provide it, the modem will automatically apply default DNS Server IP address: 194.109.6.66 to this field.</p> <p><b>Secondary DNS Server</b> - You can specify secondary DNS server IP address here because your ISP often provides you more than one DNS Server. If your ISP does not provide it, the modem will automatically apply default secondary DNS Server IP address: 194.98.0.1 to this field.</p>

After finishing this web page configuration, please click **OK** to save the settings.

## II-6-2 Port Settings

To avoid wrong connection due to the insertion of unsuitable Ethernet cable, the function of physical LAN ports can be disabled via web configuration.

LAN >> Port Settings

### Port Control

<input type="checkbox"/> Enable Port Control	Port 1	Port 2
Disable Port	<input type="checkbox"/>	<input type="checkbox"/>

### Port/Subnet Mapping

	Port 1	Port 2
Subnet	LAN-A	LAN-A

### Link Aggregation

<input type="checkbox"/> Enable LACP(Mode: 802.3ad)
---

OK Clear Cancel

Available settings are explained as follows:

Item	Description
<b>Port Control</b>	
<b>Enable Port Control</b>	Check it to enable the port control. If it is enabled, you are allowed to disable the function of physical LAN port by checking the corresponding check box.
<b>Disable Port</b>	Choose and check the LAN port.
<b>Port/Subnet Mapping</b>	
<b>Subnet</b>	When <b>Enable 2 Subnet</b> is enabled in <b>Wireless LAN &gt;&gt; General Setup</b> , you can set subnet (LAN-A or LAN-B) for LAN Port 2. In AP mode, if you specify <b>LAN-B</b> for Port 2, wireless clients on LAN-B SSIDs can access Internet through Port 2 independently. However, if you specify <b>LAN-A</b> for Port2, both LAN ports can access LAN-A while wireless clients on LAN-B SSIDs can use local service.
<b>Link Aggregation</b>	
<b>Enable LACP</b>	Enable bonding for Port1 and Port2. With this feature, users can connect Port1 and Port2 to one switch and improve multiple wireless band performance. However, the system performance will drop when LACP(Link Aggregation Control Protocol) is enabled.

After finishing this web page configuration, please click **OK** to save the settings.

# Chapter III Management



# III-1 System Maintenance

---

For the system setup, there are several items that you have to know the way of configuration: Status, TR-069, Administrator Password, Configuration Backup, Syslog/Mail Alert, Time and Date, SNMP, Management, Reboot System, and Firmware Upgrade.

Below shows the menu items for System Maintenance.

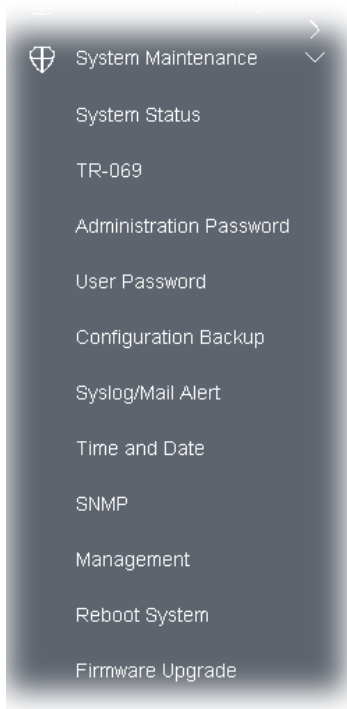

## III-1-1 System Status

The **System Status** provides basic network settings of Vigor modem. It includes LAN and WAN interface information. Also, you could get the current running firmware version or firmware related information from this presentation.

### System Status

```

Model : VigorAP1000C
Device Name : VigorAP1000C
Firmware Version : 1.4.0
Build Date/Time : g449_385ef6e55c Wed, 03 Feb 2021 14:52:39
System Uptime : 0d 02:30:51
Operation Mode : Range Extender
  
```

System	
Memory Total	: 236792 kB
Memory Left	: 78260 kB
Cached Memory	: 23208 kB / 236792 kB

LAN	
MAC Address	: 00:1D:AA:04:F2:C8
IP Address	: 192.168.1.2
IP Mask	: 255.255.255.0

Wireless LAN (2.4GHz)	
MAC Address	: 00:1D:AA:04:F2:C8
SSID	: DrayTek-04F2C8
Channel	: 11
Driver Version	: 10.4

Wireless LAN (5GHz)	
MAC Address	: 00:1D:AA:04:F2:C9
SSID	: DrayTek-04F2C8
Channel	: 36
Driver Version	: 10.4

Wireless LAN (5GHz-2)	
MAC Address	: 00:1D:AA:04:F2:CA
SSID	: DrayTek-04F2C8
Channel	: Auto(100)
Driver Version	: 10.4

**WARNING: Your AP is still set to default password. You should change it via System Maintenance menu.**

Each item is explained as follows:

Item	Description
<b>Model /Device Name</b>	Display the model name of the modem.
<b>Firmware Version</b>	Display the firmware version of the modem.
<b>Build Date/Time</b>	Display the date and time of the current firmware build.
<b>System Uptime</b>	Display the period that such device connects to Internet.
<b>Operation Mode</b>	Display the operation mode that the device used.
<b>System</b>	
<b>Memory total</b>	Display the total memory of your system.
<b>Memory left</b>	Display the remaining memory of your system.
<b>LAN</b>	
<b>MAC Address</b>	Display the MAC address of the LAN Interface.
<b>IP Address</b>	Display the IP address of the LAN interface.
<b>IP Mask</b>	Display the subnet mask address of the LAN interface.
<b>Wireless LAN (2.4GHz/5GHz/5GHz-2)</b>	
<b>MAC Address</b>	Display the MAC address of the WAN Interface.
<b>SSID</b>	Display the SSID of the device.

---

**Channel**

Display the channel that the station used for connecting with such device.

---



## III-1-2 TR-069

This device supports TR-069 standard. It is very convenient for an administrator to manage a TR-069 device (Vigor router, AP and etc.) through VigorACS (Auto Configuration Server).

### System Maintenance >> TR069 Settings

#### ACS Settings

URL	<input type="text" value="http://192.168.105.141:8080/ACSServer/services"/>	<input type="button" value="Wizard"/>
Username	<input type="text" value="acs"/>	
Password	<input type="password" value="....."/>	
	<input type="button" value="TestWith Inform"/> <input type="button" value="Event Code"/>	<input type="button" value="PERIODIC"/> ▾
Last Inform Response Time : <span style="color: red;">●</span>		

#### CPE Settings

Enable	<input checked="" type="checkbox"/>
SSL(HTTPS) Mode	<input type="checkbox"/>
On	<input type="text" value="LAN-A"/> ▾
URL	<input type="text" value="http://192.168.1.2:8069/cwm/CRN.html"/>
Port	<input type="text" value="8069"/>
Username	<input type="text" value="vigor"/>
Password	<input type="password" value="....."/>

**Note :** SSL(HTTPS) Mode only works when Vigor ACS SI is 1.1.6 and above version.  
Please set default gateway, no matter choose LAN-A or LAN-B.

#### Periodic Inform Settings

Enable	<input checked="" type="checkbox"/>
Interval Time	<input type="text" value="900"/> second(s)

#### STUN Settings

<input checked="" type="radio"/> Enable <input type="radio"/> Disable	
Server Address	<input type="text" value="192.168.105.141"/>
Server Port	<input type="text" value="8478"/>
Minimum Keep Alive Period	<input type="text" value="60"/> second(s)
Maximum Keep Alive Period	<input type="text" value="-1"/> second(s)

Available settings are explained as follows:

Item	Description
<b>ACS Settings</b>	<b>Wizard</b> – Click it to enter the IP address of VigorACS server host, port number and the handler.

	<p><b>URL/Username/Password</b> – Such data must be typed according to the ACS (Auto Configuration Server) you want to link. Please refer to Auto Configuration Server user’s manual for detailed information.</p> <p><b>Test With Inform</b> – Click it to send a message based on the event code selection to test if such CPE is able to communicate with VigorACS SI server.</p> <p><b>Event Code</b> – Use the drop down menu to specify an event to perform the test.</p> <p><b>Last Inform Response Time</b> – Display the time that VigorACS server made a response while receiving Inform message from CPE last time.</p>
<b>CPE Settings</b>	<p>Such information is useful for Auto Configuration Server (ACS).</p> <p><b>Enable</b>– Check the box to allow the CPE Client to connect with Auto Configuration Server.</p> <p><b>SSL(HTTPS) Mode</b> - Check the box to allow the CPE client to connect with ACS through SSL.</p> <p><b>On</b> – Choose the interface (LAN-A or LAN-B) for VigorAP 1000C connecting to ACS server.</p> <p><b>Port</b> – Sometimes, port conflict might be occurred. To solve such problem, you might change port number for CPE.</p> <p><b>Username/Password</b> – Type the username and password that VigorACS can use to access into such CPE.</p>
<b>Periodic Inform Settings</b>	<p>The default setting is <b>Enable</b>. Please set interval time or schedule time for the AP to send notification to VigorACS server.</p> <p><b>Interval Time</b> – Type the value for the interval time setting. The unit is “second”.</p>
<b>STUN Settings</b>	<p>The default is <b>Disable</b>.</p> <p>If you click <b>Enable</b>, please type the relational settings listed below:</p> <p><b>Server Address</b> – Type the IP address of the STUN server.</p> <p><b>Server Port</b> – Type the port number of the STUN server.</p> <p><b>Minimum Keep Alive Period</b> – If STUN is enabled, the CPE must send binding request to the server for the purpose of maintaining the binding in the Gateway. Please type a number as the minimum period. The default setting is “60 seconds”.</p> <p><b>Maximum Keep Alive Period</b> – If STUN is enabled, the CPE must send binding request to the server for the purpose of maintaining the binding in the Gateway. Please type a number as the maximum period. A value of “-1” indicates that no maximum period is specified.</p>

After finishing this web page configuration, please click **OK** to save the settings.

### III-1-3 Administrator Password

This page allows you to set new password for accessing into web user interface of VigorAP.

**System Maintenance >> Administration Password**

#### Administrator Settings

Account	<input type="text" value="admin"/>
Old Password	<input type="text"/>
New Password	<input type="text"/>
Confirm Password	<input type="text"/>
Password Strength:	<input type="button" value="Weak"/> <input type="button" value="Medium"/> <input type="button" value="Strong"/>
Strong password requirements: 1. Have at least one upper-case letter and one lower-case letter. 2. Including non-alphanumeric characters is a plus.	

**Note :** Authorization Account can contain only a-z A-Z 0-9 , ~ ` ! @ \$ % ^ \* ( ) \_ + = { } [ ] ; < > . ?  
 Authorization Password can contain only a-z A-Z 0-9 , ~ ` ! @ # \$ % ^ & \* ( ) \_ + = { } [ ] \ ;  
 < > . ? /

Available settings are explained as follows:

Item	Description
<b>Account</b>	Enter the name for accessing into web user Interface.
<b>Old Password</b>	Enter the old password for accessing into the web user interface.
<b>New Password</b>	Enter in new password in this filed.
<b>Confirm Password</b>	Enter the new password again for confirmation.
<b>Password Strength</b>	The system will display the password strength (represented with the word of weak, medium or strong) of the password specified above.

When you click **OK**, the login window will appear. Please use the new password to access into the web user interface again.

### III-1-4 User Password

This page allows you to set new account and password for accessing the web pages under User Mode.

**System Maintenance >> User Password**

#### User Password

Enable User Mode

Account

Password

Confirm Password

**Note:** Authorization Account can contain only a-z A-Z 0-9 , ~ ` ! @ \$ % ^ \* ( ) \_ + = { } [ ] | ; < > . ?  
 Authorization Password can contain only a-z A-Z 0-9 , ~ ` ! @ # \$ % ^ & \* ( ) \_ + = { } [ ] \ ;  
 < > . ? /

Available settings are explained as follows:

Item	Description
<b>Enable User Mode</b>	After checking this box, you can access into the web user interface with the password typed here for simple web configuration. The settings on simple web user interface will be different with full web user interface accessed by using the administrator password.
<b>Account</b>	Enter a user name.
<b>Password</b>	Enter in new password in this field. The length of the password is limited to 31 characters.
<b>Confirm Password</b>	Enter the new password again.

Click **OK** to save the settings.

Settings to be configured in User Mode will be less than settings in Admin Mode. Only basic configuration settings will be available in User Mode.

## III-1-5 Configuration Backup

Such function can be used to backup/restore the VigorAP 1000C settings.

**System Maintenance >> Configuration Backup**

### Configuration Backup / Restoration

**Restoration**

Select a configuration file.

Please enter the password and click Restore to upload the configuration file.

Password (optional):

**Note:** 1. You will need the same password to do configuration restoration.  
2. The configuration file from the supported model list would be adopted.

---

**Backup**

Please specify a password and click Backup to download current configuration as an encrypted file.

Protect with password

Password  (Max. 23 characters allowed)

Confirm Password

**Note:** Password can contain only a-z A-Z 0-9 , ! @ \$ % ^ \_ - + = { } [ ] . ? /

Available settings are explained as follows:

Item	Description
<b>Restoration</b>	<p><b>Browse</b> - Click it to specify a file to be restored.</p> <p><b>Password (optional)</b> - Enter a password for configuration restoration.</p> <p><b>Restore</b> - Click it to restore the configuration file to VigorAP.</p>
<b>Backup</b>	<p>Perform the configuration backup of this device.</p> <p><b>Protect with password</b>- For the sake of security, the configuration file for the access point can be encrypted.</p> <p><b>Password</b> - Type several characters as the password for encrypting the configuration file.</p> <p><b>Confirm Password</b> - Type the password again for confirmation.</p> <p><b>Backup</b> - Click it to backup the configuration file.</p>

Follow the steps below to backup your configuration.

1. Go to **System Maintenance >> Configuration Backup**.
2. If required, check the box of Protect with password and enter the password.
3. Click **Backup** to get into the following dialog. The configuration will download automatically to your computer as a file named **config.cfg**.

The above example is using **Windows** platform for demonstrating examples. The **Mac** or **Linux** platform will appear different windows, but the backup function is still available.

---

 **Note:**

Backup for Certification must be done independently. The Configuration Backup does not include information of Certificate.

---

Follow the steps below to restore your configuration.

1. Go to **System Maintenance >> Configuration Backup**.
2. Click **Upload** to choose the correct configuration file for uploading to the AP.
3. Click **Restore** and wait for few seconds.

## III-1-6 Syslog/Mail Alert

SysLog function is provided for users to monitor AP. There is no bother to directly get into the Web user interface of the AP or borrow debug equipments.

System Maintenance >> Syslog / Mail Alert Setup

### Syslog Access Setup

Enable	<input type="checkbox"/>
Server IP Address	<input type="text"/>
Destination Port	<input type="text" value="514"/>
Log Level	<input type="text" value="All"/>

### Mail Alert Setup

Enable	<input type="checkbox"/>
SMTP Server	<input type="text"/>
SMTP Server Port	<input type="text"/>
Mail To	<input type="text"/>
Mail From	<input type="text"/>
User Name	<input type="text"/>
Password	<input type="text"/>
Use TLS	<input checked="" type="checkbox"/>
Enable E-Mail Alert:	
<input checked="" type="checkbox"/> When Admin Login AP	

Available settings are explained as follows:

Item	Description
<b>Syslog Access Setup</b>	<p><b>Enable</b> - Check <b>Enable</b> to activate function of Syslog.</p> <p><b>Server IP Address</b> -The IP address of the Syslog server.</p> <p><b>Destination Port</b> -Assign a port for the Syslog protocol. The default setting is 514.</p> <p><b>Log Level</b> - Specify which level of the severity of the event will be recorded by Syslog.</p>
<b>Mail Alert Setup</b>	<p><b>Enable</b> - Check <b>Enable</b> to activate function of mail alert.</p> <p><b>SMTP Server</b> - Enter the IP address of the SMTP server.</p> <p><b>SMTP Server Port</b> - Set the port value for the SMTP server.</p>

	<p><b>Mail To</b> - Assign a mail address for sending mails out.</p> <p><b>Mail From</b> - Assign a path for receiving the mail from outside.</p> <p><b>User Name</b> - Enter the user name for authentication.</p> <p><b>Password</b> - Enter the password for authentication.</p> <p><b>Use TLS</b> - Check this box to encrypt alert mail. However, if the SMTP server specified here does not support TLS protocol, the alert mail with encrypted data will not be received by the receiver.</p> <p><b>Enable E-Mail Alert</b> - VigorAP will send an e-mail out when a user accesses into the user interface by using web or telnet.</p> <p><b>When Admin Login AP</b> - Enable/disable the function. When it is enabled, VigorAP will send out an e-mail to the recipient defined above when a user tries to access into VigorAP by entering login username and password.</p>
--	---

Click **OK** to save the settings.

### III-1-7 Time and Date

It allows you to specify where the time of VigorAP should be inquired from.

System Maintenance >> Time and Date

#### Time Information

Current System Time	2020 Mar 2 Mon 09:48:00	Inquire Time
status	NTP time synchronized	

#### Time Setting

<input checked="" type="checkbox"/> Enable NTP Client		
Time Zone	(GMT+08:00) China Beijing, Chongqing	▼
NTP Server	pool.ntp.org	Use Default
Daylight Saving	<input type="checkbox"/>	
NTP synchronization	1 day	▼

OK Cancel

Available parameters are explained as follows:

Item	Description
<b>Current System Time</b>	Click <b>Inquire Time</b> to get the current time.
<b>Enable NTP Client</b>	<p>Select to inquire time information from Time Server on the Internet using assigned protocol.</p> <ul style="list-style-type: none"> <li>● <b>Time Zone</b> - Select a time protocol.</li> <li>● <b>NTP Server</b> - Type the IP address of the time server.</li> <li>● <b>Use Default</b> - Click it to choose the default NTP server.</li> <li>● <b>Daylight Saving</b> - Check the box to enable the daylight saving. Such feature is available for certain area.</li> </ul>



	<ul style="list-style-type: none"><li>● <b>NTP synchronization</b> - Select a time interval for updating from the NTP server.</li></ul>
<b>OK</b>	Save the settings.

Click **OK** to save these settings.

## III-1-8 SNMP

This page allows you to configure settings for SNMP and SNMPV3 services.

The SNMPv3 is **more secure than** SNMP through the authentication method (support e.g., MD5) for the management needs.

System Maintenance >> SNMP

### SNMP Agent

<input type="checkbox"/> Enable SNMPv1 / SNMPv2c Agent	
Get Community	public
<input type="checkbox"/> Enable SNMPv3 Agent	
USM User	
Auth Algorithm	No Auth
Auth Password	

Note: SNMP V1/V2c is read-only and SNMP V3 is read-write.

OK

Cancel

Available settings are explained as follows:

Item	Description
<b>Enable SNMPv1 / SNMPv2 Agent</b>	Check it to enable this function.
<b>Enable SNMPV3 Agent</b>	Check it to enable this function.
<b>USM User</b>	USM means user-based security mode. Type a username which will be used for authentication. The maximum length of the text is limited to 23 characters.
<b>Auth Algorithm</b>	Choose one of the encryption methods listed below as the authentication algorithm.
<b>Auth Password</b>	Type a password for authentication. The maximum length of the text is limited to 23 characters.

Click **OK** to save these settings.

## III-1-9 Management

This page allows you to specify the port number for HTTP and HTTPS server.

System Maintenance >> Management

Device Name

---

**Access Control**

Allow management from WLAN

Enable Telnet Server

Disable Reset Button

---

**Access List**

Enable access list

List	IP	Mask
1.	<input type="text"/>	255.255.255.255 / 32 <input type="button" value="v"/>
2.	<input type="text"/>	255.255.255.255 / 32 <input type="button" value="v"/>
3.	<input type="text"/>	255.255.255.255 / 32 <input type="button" value="v"/>
4.	<input type="text"/>	255.255.255.255 / 32 <input type="button" value="v"/>
5.	<input type="text"/>	255.255.255.255 / 32 <input type="button" value="v"/>

**Port Setup**

HTTP Port  ( Default:80 )

HTTPS Port  ( Default:443 )

---

**Panel Control**

Disable LED

Enable Default Configuration Wizard

Available parameters are explained as follows:

Item	Description
<b>Device Name</b>	The default setting is VigorAP 1000C. Change the name if required.
<b>Access Control</b>	<p><b>Allow management from WLAN</b> - Enable the checkbox to allow system administrators to login from wireless LAN.</p> <p><b>Enable Telnet Server</b>- The administrator / user can access into the command line interface of VigorAP remotely for configuring settings.</p> <p><b>Disable Reset Button</b> - If enabled, the function of the <b>Reset</b> button will be invalid.</p>
<b>Access List</b>	<b>Enable access list</b> - Check the box to specify that the system administrator can only login from a specific host or network defined in the list. A maximum of five IPs/subnet masks is allowed.
<b>Port Setup</b>	<b>HTTP port/HTTPS port</b> -Specify user-defined port numbers for the HTTP and HTTPS servers.
<b>Panel Control</b>	<b>Disable LED</b> - The LEDs blink always since VigorAP is powered on. Some people might not like that. Therefore the function of LED is allowed to be disabled to make people feeling comfortable and

---

undisturbed. After checking it, all the LEDs on VigorAP will light off immediately after clicking OK.

**Enable Default Configuration Wizard** – Default setting is enabled. When it is enabled, you will be guided into **Quick Start Wizard** whenever clicking the DrayTek logo on the top of the web user interface.

Such function will be disabled if you have configured Operation Mode, WLAN>>General Setup, WLAN>>Bandwidth Management, WLAN>>Station Control or System Maintenance>>Administration Password.

---

Click **OK** to save these settings.

## III-1-10 Reboot System

The web user interface may be used to restart your modem. Click **Reboot System** from **System Maintenance** to open the following page.

**System Maintenance >> Reboot System**

---

### Reboot System

**Do You want to reboot your AP ?**

Using current configuration

Using factory default configuration

OK

If you want to reboot the modem using the current configuration, check **Using current configuration** and click **OK**. To reset the modem settings to default values, check **Using factory default configuration** and click **OK**. The modem will take 5 seconds to reboot the system.

---

### Note:

When the system pops up Reboot System web page after configuring the web settings, please click **OK** to reboot your device for ensuring normal operation and preventing unexpected errors of the modem in the future.

---

## III-1-11 Firmware Upgrade

Before upgrading your modem firmware, you need to install the Modem Tools. The **Firmware Upgrade Utility** is included in the tools. The following web page will guide you to upgrade firmware by using an example. Note that this example is running over Windows OS (Operating System).

Download the newest firmware from DrayTek's web site or FTP site. The DrayTek web site is [www.draytek.com](http://www.draytek.com) (or local DrayTek's web site) and FTP site is <ftp.draytek.com>.

Click **System Maintenance**>> **Firmware Upgrade** to launch the Firmware Upgrade Utility.

### System Maintenance >> Firmware Upgrade

#### Firmware Update

Select a firmware file.

Click Upgrade to upload the file.

#### Firmware Version Status

[Refresh Latest Firmware](#)

Current Firmware Version	: 1.3.3
The Latest Firmware Version	: N/A

Click **Download** to locate the newest firmware from your hard disk and click **Upgrade**.

### System Maintenance >> Firmware Upgrade

#### Firmware Update

Firmware Upgrade is in progress... It must NOT be interrupted!



#### Firmware Version Status

[Refresh Latest Firmware](#)

Current Firmware Version	: 1.3.3
The Latest Firmware Version	: N/A

## III-2 Central AP Management

Such menu allows you to configure VigorAP device to be managed by Vigor router.

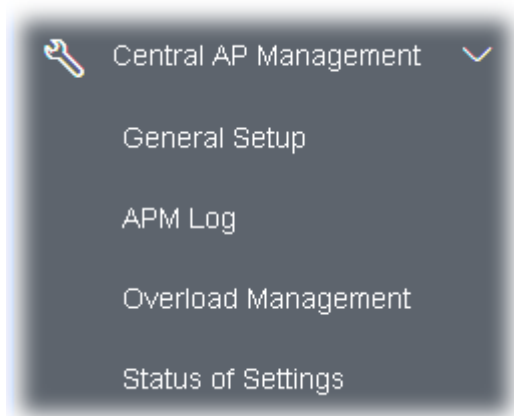

### III-2-1 General Setup

Central AP Management >> General Setup

Management by VigorRouter / RootAP

- Enable NodeAP
- Enable Auto Provision

Note: LAN-B cannot support APM feature.

OK

Cancel

Available settings are explained as follows:

Item	Description
<b>Enable AP Management</b>	Check the box to enable the function of AP Management (APM).
<b>Enable Auto Provision</b>	VigorAP 1000C can be controlled under Central AP Management in Vigor2865 series. When both Vigor2865 series and VigorAP 1000C have such feature enabled, once VigorAP 1000C is registered to Vigor2865 series, the <b>WLAN profile</b> pre-configured on Vigor2862 series will be applied to VigorAP 1000C immediately. Thus, it is not necessary to configure VigorAP 1000C separately.

Click **OK** to save these settings.

## III-2-2 APM Log

This page will display log information related to wireless stations connected to VigorAP 1000C and central AP management.

Such information also will be delivered to Vigor router (e.g., Vigor2862 or Vigor2926 series) and be shown on **Central AP Management>>Event Log** of Vigor router.

### Central AP Management >> APM Log

---

#### APM Log Information

| [Clear](#) | [Refresh](#) |  [Line wrap](#) |

```
Aug 24-13:02:54 syslog: [APM] Request done.
Aug 24-10:47:27 syslog: [APM] Get Traffic data.
Aug 24-10:47:27 syslog: [APM] Request done.
Aug 24-10:52:28 syslog: [APM] Get Traffic data.
Aug 24-10:52:28 syslog: [APM] Request done.
Aug 24-10:42:26 syslog: [APM] Get Traffic data.
Aug 24-10:42:26 syslog: [APM] Request done.
Aug 24-10:47:27 syslog: [APM] Get Traffic data.
Aug 24-10:47:27 syslog: [APM] Request done.
Aug 24-10:52:28 syslog: [APM] Get Traffic data.
Aug 24-10:52:28 syslog: [APM] Request done.
Aug 24-10:57:29 syslog: [APM] Get Traffic data.
Aug 24-10:57:29 syslog: [APM] Request done.
Aug 24-11:02:30 syslog: [APM] Get Traffic data.
Aug 24-11:02:30 syslog: [APM] Request done.
Aug 24-11:07:31 syslog: [APM] Get Traffic data.
```



### III-2-3 Overload Management

Load Balance can help to distribute the traffic for all of the access points (e.g., VigorAP 1000C) registered to Vigor router. Thus, the bandwidth will not be occupied by certain access points.

However, traffic overload might be occurred if too many wireless stations connected to VigorAP 1000C for data incoming and outgoing. Therefore, "Force Overload Disassociation" is required to terminate the network connection of the client's station to release network traffic. When the function of "Force Overload Disassociation" in web user interface of Vigor router (e.g., Vigor2860 or Vigor2925 series) is enabled, wireless clients specified in **black list** of such web page will be disassociated to solve the problem of traffic overload.

The following web page is used to configure white list and black list for wireless stations.

Central AP Management >> Overload Management

#### Overload Management

**MAC Address Filter of Force Overload Disassociation**

Index	MAC Address	Comment
<b>White List</b>		
<b>Black List</b>		

Client's MAC Address :  :  :  :  :  :

Apply to : White List ▾

Comment :

**Note:** When force overload disassociation is enabled, clients in black list will be disassociated first. Clients in white list will not be disassociated.

Available settings are explained as follows:

Item	Description
<b>White List/Black List</b>	<p>Display the information (such as index number, MAC address and comment) for all of the members in White List/Black List.</p> <p>Wireless stations listed in Black List will be forcefully disconnected first when traffic overload occurs and "Force Overload Disassociation" is enabled.</p>
<b>Client's MAC Address</b>	Specify the MAC Address of the remote/local client.
<b>Apply to</b>	<p><b>White List</b> – MAC address listed inside Client's MAC Address will be categorized as one of members in White List.</p> <p><b>Black List</b> - MAC address listed inside Client's MAC Address will be categorized as one of members in Black List.</p>

<b>Comment</b>	Type a brief description for the specified client's MAC address.
<b>Add</b>	Add a new MAC address into the White List/Black List.
<b>Delete</b>	Delete the selected MAC address in the White List/Black List.
<b>Edit</b>	Edit the selected MAC address in the White List/Black List.
<b>Cancel</b>	Give up the configuration.

Click **OK** to save these settings.

### III-2-4 Status of Settings

Load Balance can help to distribute the traffic for all of the access points (e.g., VigorAP 1000C) registered to Vigor 2862 or Vigor2926 series. This web page displays the settings related to Load Balance for VigorAP 1000C. In which, Station Number Threshold, Traffic Threshold and Force Overload Disassociation indicate settings configured in Vigor 2862 or Vigor2926 series.

#### Central AP Management >> Status of Settings

Function Name	Status	Value
<b>Load Balance</b>		
Station Number Threshold	X	
Max WLAN(2.4GHz) Station Number		128
Max WLAN(5GHz) Station Number		128
Max WLAN(5GHz-2) Station Number		128
Traffic Threshold	X	
Upload Limit		None bps
Download Limit		None bps
Force Overload Disassociation	X	
Disassociate By		None
RSSI Threshold		-50 dBm
<b>Rogue AP Detection</b>		
Rogue AP Detection	X	

"X" means the function is not enabled or VigorAP 1000C has not registered to any Vigor router yet.

Below shows a setting example for Load Balance settings configured in Vigor 2862 or Vigor2926 series.

**AP Load Balance**

By Station Number or Traffic

**Station Number Threshold**

---

Wireless LAN (2.4GHz)  (3-128)

Wireless LAN (5GHz)  (3-128)

**Traffic Threshold**

---

Upload Limit   bps (Default unit: K)

Download Limit   bps (Default unit: K)

**Action When Threshold Exceeded**

---

- Stop accepting new connections
- Dissociate existing station by longest idle time
- Dissociate existing station by worst signal strength if it is less than -  dBm (  %)

# III-3 Mobile Device Management

Such feature can control / manage the mobile devices accessing the wireless network of VigorAP. VigorAP offers wireless LAN service for mobile device(s), PC users, MAC users or other users according to the policy selected.

Below shows the menu items for Mobile Device Management (MDM).

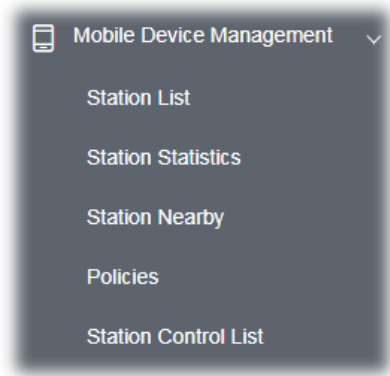

## III-3-1 Station List

**Station List** provides the information related to the number of clients connecting to VigorAP, used bandwidth and the statistics of the AP device OS. Besides, users can create access control policies, device objects and set black & white list for

### III-3-1-1 Connected Number

This page lists the graph for the number of wireless stations connected to this Access Point with different time phases.

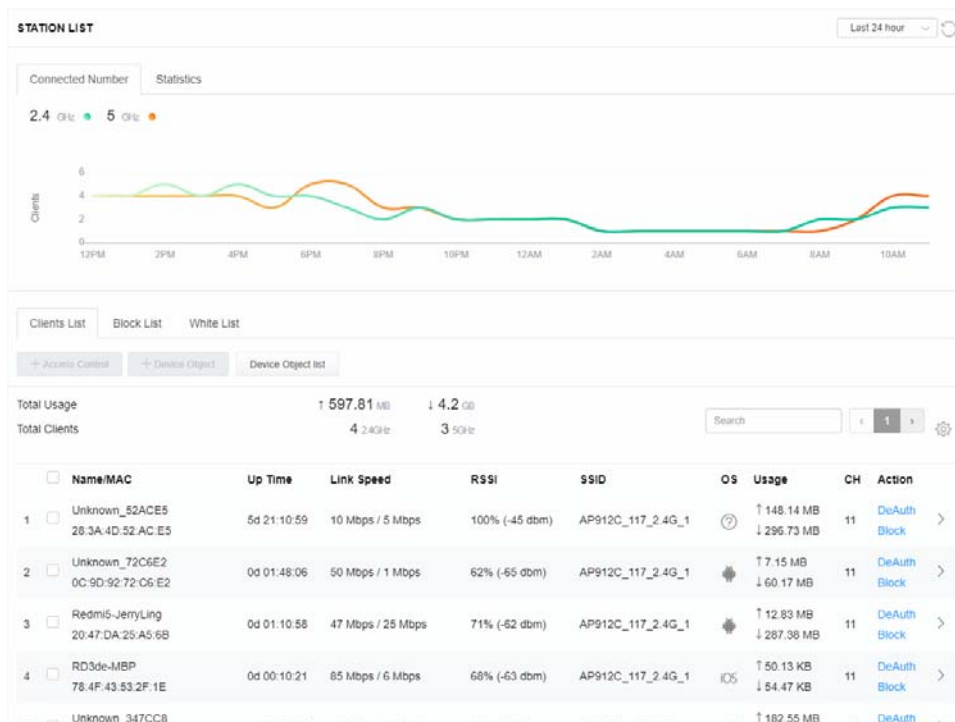

### III-3-1-2 Statistics

The number of detected devices and the number of device(s) passed/blocked according to the policy specified in **Mobile Device Management>>Policies** can be illustrated as doughnut chart.

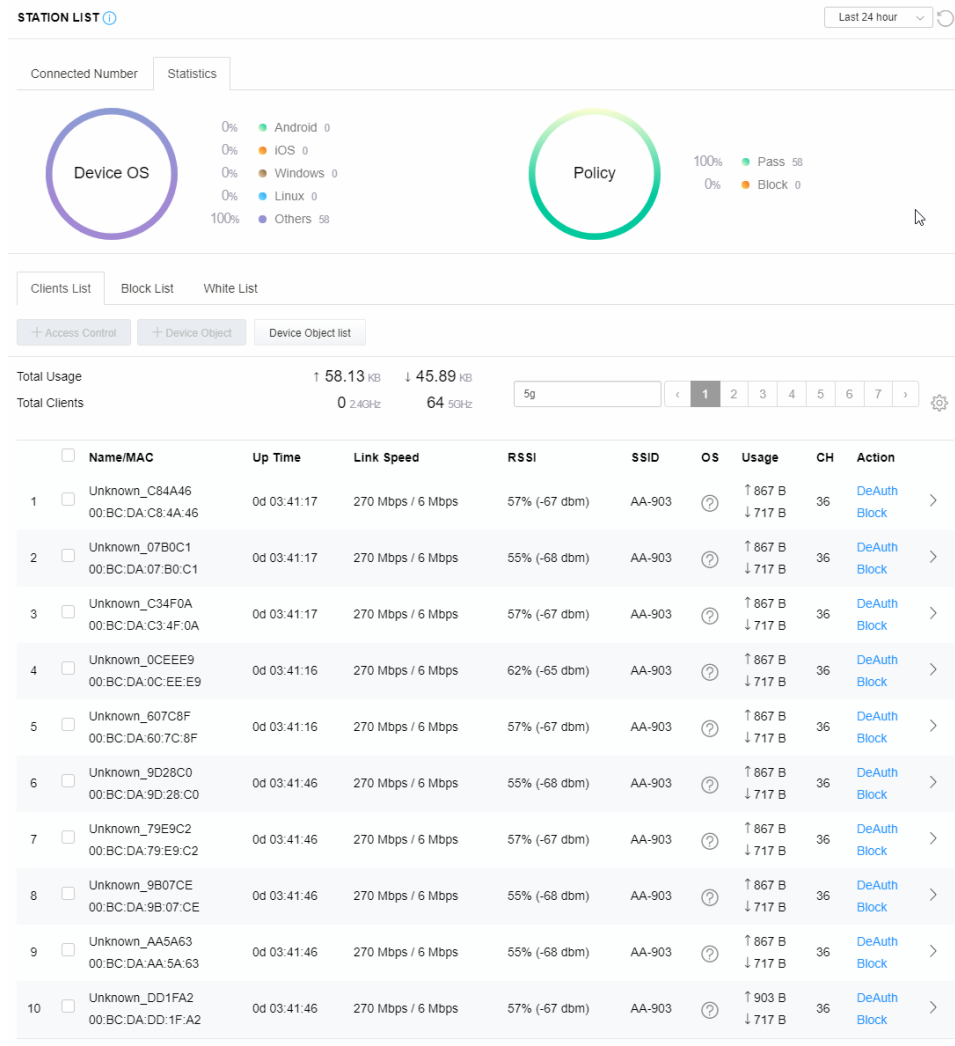

### III-3-1-3 Clients List

The client list displays all the stations connecting to VigorAP.

**STATION LIST** ⓘ Last 24 hour ↻

---

Connected Number Statistics

**Device OS**

- 0% Android 0
- 0% iOS 0
- 0% Windows 0
- 0% Linux 0
- 100% Others 58

**Policy**

- 100% Pass 58
- 0% Block 0

---

Clients List Block List White List

+ Access Control
+ Device Object
Device Object list

---

Total Usage ↑ 58.13 KB ↓ 45.89 KB

Total Clients 0 2.4GHz 64 5GHz
5g
< 1 2 3 4 5 6 7 >
⚙️

<input type="checkbox"/>	Name/MAC	Up Time	Link Speed	RSSI	SSID	OS	Usage	CH	Action
<input type="checkbox"/>	Unknown_C84A46 00:BC:DA:C8:4A:46	0d 03:42:47	270 Mbps / 6 Mbps	57% (-67 dbm)	AA-903	?	↑ 867 B ↓ 717 B	36	DeAuth Block
<input checked="" type="checkbox"/>	Unknown_07B0C1 00:BC:DA:07:B0:C1	0d 03:42:47	270 Mbps / 6 Mbps	55% (-68 dbm)	AA-903	?	↑ 867 B ↓ 717 B	36	DeAuth Block
<input checked="" type="checkbox"/>	Unknown_C34F0A 00:BC:DA:C3:4F:0A	0d 03:42:47	270 Mbps / 6 Mbps	57% (-67 dbm)	AA-903	?	↑ 867 B ↓ 717 B	36	DeAuth Block
<input type="checkbox"/>	Unknown_0CEEE9 00:BC:DA:0C:EE:E9	0d 03:42:46	270 Mbps / 6 Mbps	62% (-65 dbm)	AA-903	?	↑ 867 B ↓ 717 B	36	DeAuth Block

Available settings are explained as follows:

Item	Description									
<b>+Access Control</b>	<p>It is available after choosing one of the entries (clients) on Clients List.</p> <div style="border: 1px solid #ccc; padding: 10px; margin: 10px 0;"> <p><b>Add Access Control</b> ⓘ</p> <p>Wireless LAN <span style="margin-left: 20px;">5GHz</span></p> <hr/> <p>SSID Policy</p> <p>1 Black list AA-903    2 Disable AA-903-2    3 Disable AA-903-3    4 Disable AA-903-4</p> <hr/> <p>From to list</p> <table style="width: 100%; border-collapse: collapse;"> <thead> <tr> <th style="width: 20%;">Device MAC</th> <th style="width: 30%;">Name</th> <th style="width: 50%;">Apply to SSID</th> </tr> </thead> <tbody> <tr> <td>00:BC:DA:07:B0:C1</td> <td>Unknown_07B0C1</td> <td><input type="checkbox"/> All <input type="checkbox"/> 1 <input type="checkbox"/> 2 <input type="checkbox"/> 3 <input type="checkbox"/> 4</td> </tr> <tr> <td>00:BC:DA:C3:4F:0A</td> <td>Unknown_C34F0A</td> <td><input type="checkbox"/> All <input type="checkbox"/> 1 <input type="checkbox"/> 2 <input type="checkbox"/> 3 <input type="checkbox"/> 4</td> </tr> </tbody> </table> <p style="font-size: small; color: red;">Total : 0/256</p> <p style="text-align: right;">Close <span style="background-color: #00a651; color: white; padding: 2px 5px;">Save changes</span></p> </div> <p><b>Wireless LAN</b> - Specify the bandwidth for the access control list.</p> <p><b>SSID Policy</b> - Set the policy for each SSID as black list or white list or disable.</p> <p><b>From to list</b> - Display the clients available for applying this access</p>	Device MAC	Name	Apply to SSID	00:BC:DA:07:B0:C1	Unknown_07B0C1	<input type="checkbox"/> All <input type="checkbox"/> 1 <input type="checkbox"/> 2 <input type="checkbox"/> 3 <input type="checkbox"/> 4	00:BC:DA:C3:4F:0A	Unknown_C34F0A	<input type="checkbox"/> All <input type="checkbox"/> 1 <input type="checkbox"/> 2 <input type="checkbox"/> 3 <input type="checkbox"/> 4
Device MAC	Name	Apply to SSID								
00:BC:DA:07:B0:C1	Unknown_07B0C1	<input type="checkbox"/> All <input type="checkbox"/> 1 <input type="checkbox"/> 2 <input type="checkbox"/> 3 <input type="checkbox"/> 4								
00:BC:DA:C3:4F:0A	Unknown_C34F0A	<input type="checkbox"/> All <input type="checkbox"/> 1 <input type="checkbox"/> 2 <input type="checkbox"/> 3 <input type="checkbox"/> 4								

	<p>control.</p> <p><b>Apply to SSID</b> - Check <b>All</b> to make the device apply the policies to all SSIDs. Or select the one(s) to make the device apply the policies to the selected SSIDs.</p> <p><b>Close</b> - Exit this page without saving any changes.</p> <p><b>Save changes</b> - Save the changes and exit this page.</p>
<p><b>+Device Object</b></p>	<p>To add a device to device object list, choose one of the entries (clients) on Clients List to enable the Device Object button. Click the button to open the following page.</p> <div data-bbox="651 555 1396 1008" data-label="Image"> </div> <p>Check the information listed on the page. Change the MAC address or name of the selected entry if required. Then click <b>OK</b> and exit the page.</p>
<p><b>Device Object list</b></p>	<p>The existed device object profiles will be shown on the following page.</p> <div data-bbox="643 1220 1396 1444" data-label="Image"> </div>
<p><b>Clients List</b></p>	<p>Display the stations connecting to this Vigor device.</p> <p><b>Total Usage</b> - Display</p> <p><b>Total Clients</b> - Display the number of the clients using 2.4GHz</p> <p><b>Name / MAC</b> - Display the host name / MAC address of the connecting client.</p> <p><b>Up Time</b> - Display the connection time.</p> <p><b>Link Speed</b>- Display the link speed.</p> <p><b>RSSI</b> - Display the RSSI value.</p> <p><b>SSID</b> - Display the SSID the client used for connecting VigorAP.</p> <p><b>OS</b> - Display the OS of the client.</p> <p><b>Usage</b> - Display the bandwidth usage (up and down) of the client.</p> <p><b>CH</b> - Display the channel used by the client.</p> <p><b>Action</b> - Display the authentication method used by the client, and if it is on block list or white list.</p>

### II-3-13-4 Block List

This page displays information of the stations under block list.

**STATION LIST** ⓘ Last 24 hour ↕

---

Connected Number Statistics

2.4 GHz ● 5 GHz ●

---

Clients List Block List White List

+ Access Control + Device Object Device Object list

Search ⚙️

< 1 >

	Name / MAC	SSID	Reason	Action
1	Unknown_457823 00:BC:DB:45:78:23	AA-903	ACL	<a href="#">Unblock</a>
2	Unknown_A566C8 00:BC:DB:A5:66:C8	AA-903	ACL	<a href="#">Unblock</a>
Total list		2		

Available settings are explained as follows:

Item	Description
<b>Device Object list</b>	Click it to open the Device Object List dialog for reference. 
<b>Name / MAC</b>	Display the host name / MAC Address for the connecting client.
<b>SSID</b>	Display the SSID that the wireless client connects to.
<b>Reason</b>	Display the reference information.
<b>Action</b>	Display the action that you can execute for the station. <b>Unblock</b> - Click to unblock the entry.



### III-3-1-5 White List

This page displays general information of the stations under white list.

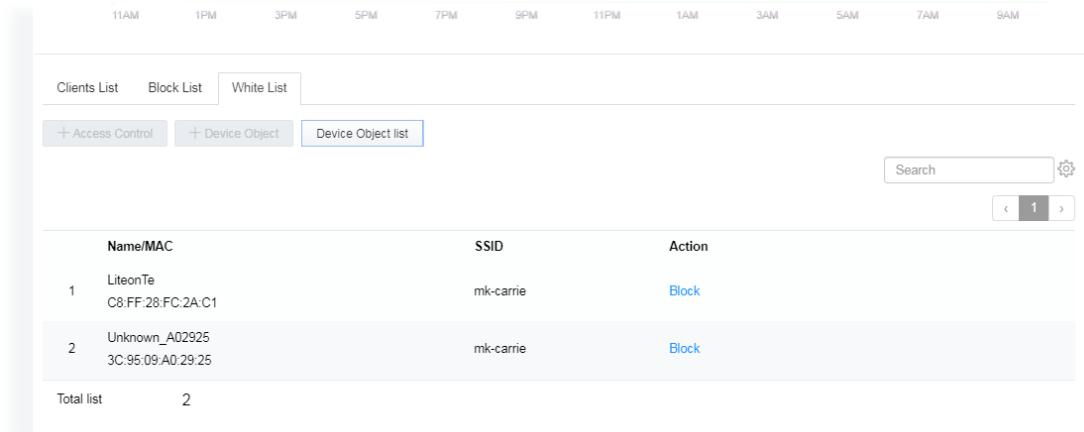

Available settings are explained as follows:

Item	Description
<b>Device Object list</b>	Click it to open the Device Object List dialog for reference. 
<b>Name / MAC</b>	Display the host name / MAC Address for the connecting client.
<b>SSID</b>	Display the SSID that the wireless client connects to.
<b>Action</b>	Display the action that you can execute for the station. <b>Block</b> - Click to block the entry.

### III-3-2 Station Statistics

This page is used for debug or for the user to observe network traffic and network quality.

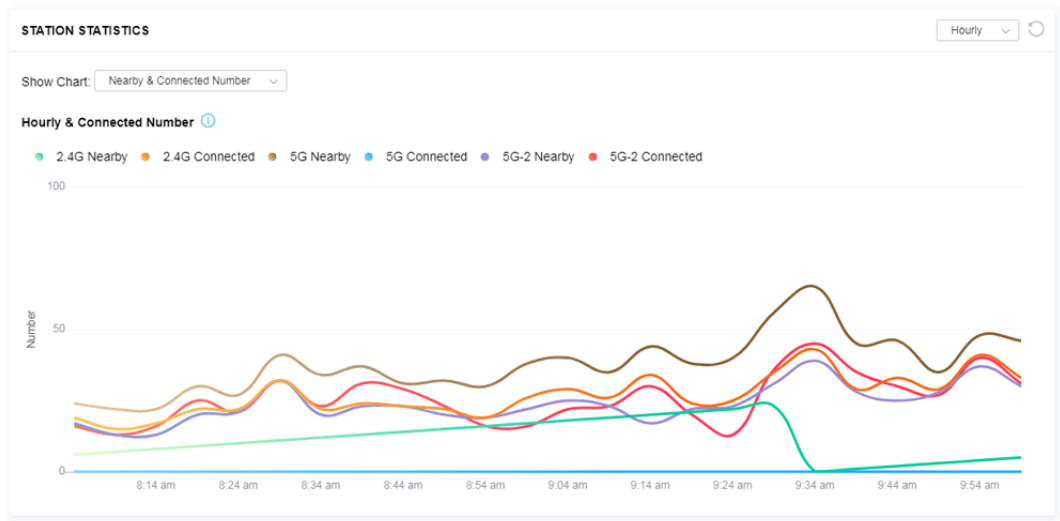

Available parameters are explained as follows:

Item	Description
<p><b>Show Chart</b></p>	<p>Choose one of the items to display the statistics chart for wireless stations.</p> <div data-bbox="671 1115 1091 1368" style="border: 1px solid #ccc; padding: 5px; margin: 10px 0;"> <p>↑ Nearby &amp; Connected Number ▾</p> <p>↑ <b>Nearby &amp; Connected Number</b> ✓</p> <p>↑ Visiting &amp; Passing Number</p> <p>↑ Visiting Time</p> </div> <p><b>Nearby &amp; Connected Number</b> – Choose it to have the statistics of the wireless stations which is nearby and connected to VigorAP 1000C.</p> <p><b>Visiting &amp; Passing Number</b> – Choose it to have the statistics of the wireless stations which is visiting and passing to VigorAP 1000C.</p> <p><b>Visiting Time</b> - Choose it to have the statistics of the wireless stations which is visiting VigorAP 1000C.</p>

### III-3-3 Station Nearby

This page displays the general information for the nearby stations.

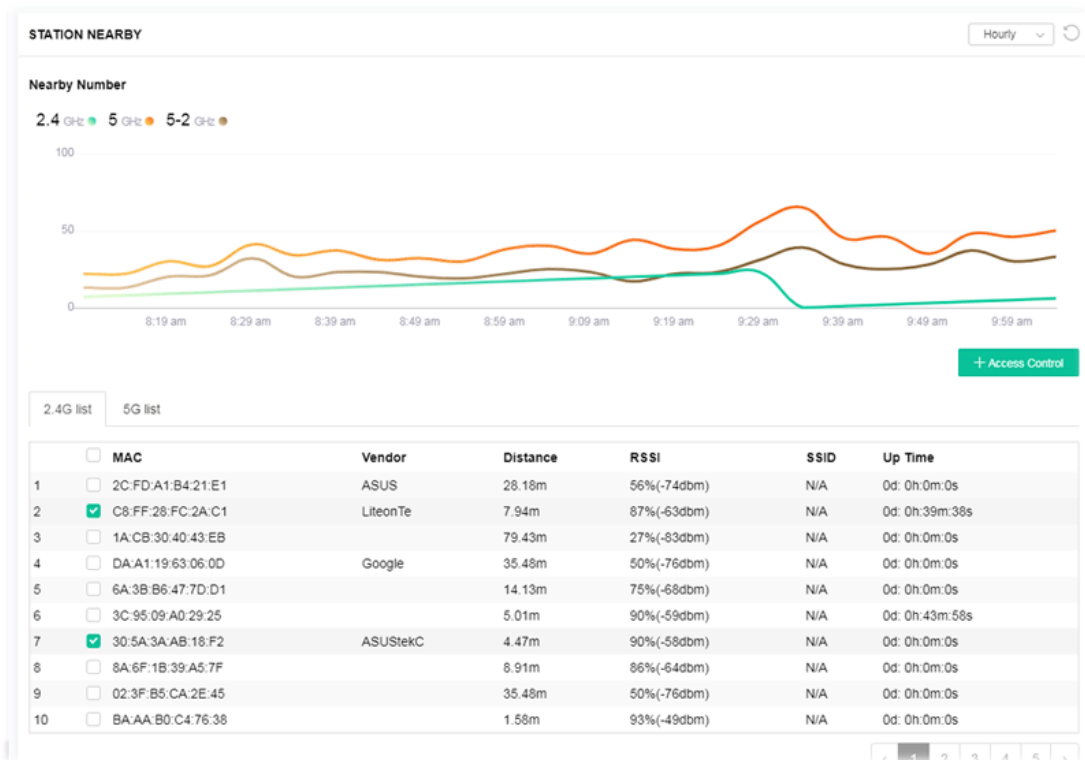

You can select the station(s) and click **+Access Control** to configure the nearby stations as the one(s) to pass through VigorAP or to be blocked by VigorAP.

The screenshot shows the 'Add Access Control' dialog box. It has a close button (X) in the top right corner. The 'Wireless LAN' section shows a dropdown menu set to '2.4GHz'. The 'SSID Policy' section has four dropdown menus, all set to 'Disable', with labels 'DrayTek-04F2C8', 'marketing', 'N/A', and 'N/A' below them. The 'From to list' section contains a table with columns for 'Device MAC', 'Name', and 'Apply to SSID'. Two stations are selected:

Device MAC	Name	Apply to SSID
C8:FF:28:FC:2A:C1	LiteonTe	<input type="checkbox"/> All <input type="checkbox"/> 1 <input type="checkbox"/> 2 <input type="checkbox"/> 3 <input type="checkbox"/> 4
30:5A:3A:AB:18:F2	ASUStekC	<input type="checkbox"/> All <input type="checkbox"/> 1 <input type="checkbox"/> 2 <input type="checkbox"/> 3 <input type="checkbox"/> 4

At the bottom left, it says 'Total : 0/256'. At the bottom right, there are 'Close' and 'Save changes' buttons.

Available parameters are explained as follows:

Item	Description
<b>SSID Policy</b>	Determine the policy (disable, white list or black list) applied for the SSID (1 to 4).
<b>From to list</b>	<p><b>Device MAC</b> - Display the MAC address of the selected station.</p> <p><b>Name</b> - Display the name of the selected station.</p> <p><b>Apply to SSID</b> - Check the box(es) to apply the SSID to the selected station.</p> <p><b>Close</b> - Exit the dialog without saving the changes.</p> <p><b>Save changes</b> - Save the changes and exit the dialog.</p>

### III-3-4 Policies

Such page determines which devices (mobile, PC, MAC or others) allowed to make network connections via VigorAP or blocked by VigorAP.

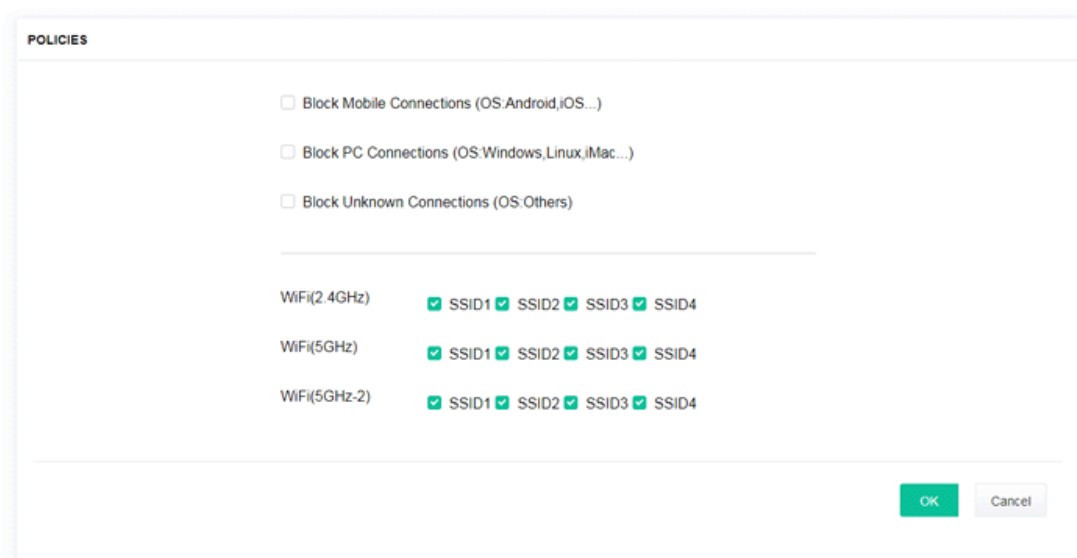

Each item is explained as follows:

Item	Description
<b>Block Mobile Connections</b>	All of mobile devices will be blocked and not allowed to access into Internet via VigorAP.
<b>Block PC Connections</b>	All of network connections based on PC, MAC or Linux platform will be blocked and terminated.
<b>Block Unknown Connections</b>	Only the unknown network connections (unable to be recognized by Vigor router) will be blocked and terminated.
<b>WiFi(2.4GHz)</b>	Specify the SSID(s) to apply such policy.
<b>WiFi(5GHz)</b>	Specify the SSID(s) to apply such policy.
<b>WiFi(5GHz-2)</b>	Specify the SSID(s) to apply such policy.

After finished the policy selection, click **OK**. VigorAP will *reboot* to activate the new policy automatically.

## III-3-5 Station Control List

This page displays information related to the wireless stations connecting to the Vigor AP.

**STATION CONTROL LIST**

   ● Online    ● Offline ↻

	SSID	MAC	Connection Time	Reconnection Time
1	● AP912C_117_2.4G_1	28:3A:4D:52:AC:E5	0d 00:58:50	0d 00:00:00
2	● AP912C_117_2.4G_1	20:47:DA:25:A5:6B	0d 00:48:22	0d 00:00:00
3	● AP912C_117_5G_1	40:4E:36:5E:3F:A7	0d 00:59:55	0d 00:00:00
4	● AP912C_117_5G_1	D0:37:45:34:7C:C8	0d 00:56:02	0d 00:00:00

ⓘ This page is available when [Station Control](#) is enabled.

This page is left blank.

# Chapter IV Others



# IV-1 RADIUS Setting

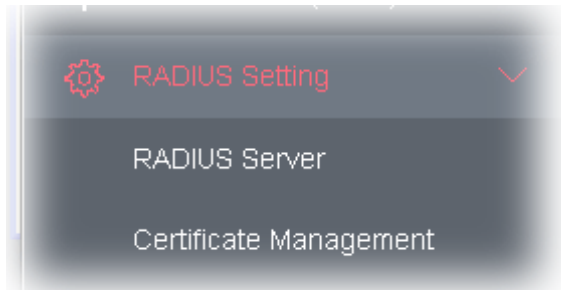

## IV-1-1 RADIUS Server

VigorAP 1000C offers a built-in RADIUS server to authenticate the wireless client that tries to connect to VigorAP 1000C. The AP can accept the wireless connection authentication requested by wireless clients.

RADIUS Setting >> RADIUS Server Configuration

Enable RADIUS Server

Authentication Type

<b>Radius EAP Type</b>	PEAP <input type="button" value="v"/>
------------------------	---------------------------------------

Users Profile (up to 256 users)

Username	Password	Confirm Password	Configure
<input type="text"/>	<input type="text"/>	<input type="text"/>	<input type="button" value="Add"/> <input type="button" value="Cancel"/>
NO.	Username	Select	
<input type="button" value="Delete Selected"/>	<input type="button" value="Delete All"/>		

Authentication Client (up to 16 clients)

Client IP	Secret Key	Confirm Secret Key	Configure
<input type="text"/>	<input type="text"/>	<input type="text"/>	<input type="button" value="Add"/> <input type="button" value="Cancel"/>
NO.	Client IP	Select	
<input type="button" value="Delete Selected"/>	<input type="button" value="Delete All"/>		

Backup Radius Cfg :  Upload From File:



Available settings are explained as follows:

Item	Description
<b>Enable RADIUS Server</b>	Check it to enable the internal RADIUS server.
<b>Authentication Type</b>	Let the user to choose the authentication method for RADIUS server.  <b>Radius EAP Type</b> – There are two types, PEAP and EAP TLS, offered for selection. If EAP TLS is selected, a certificate must be installed or must be ensured to be trusted.
<b>Users Profile</b>	<b>Username</b> – Type a new name for the user profile. <b>Password</b> – Type a new password for such new user profile. <b>Confirm Password</b> – Retype the password to confirm it. <b>Configure</b> <ul style="list-style-type: none"> <li>● <b>Add</b> – Make a new user profile with the name and password specified on the left boxes.</li> <li>● <b>Cancel</b> – Clear current settings for user profile.</li> </ul> <b>Delete Selected</b> – Delete the selected user profile (s). <b>Delete All</b> – Delete all of the user profiles.
<b>Authentication Client</b>	This internal RADIUS server of VigorAP 1000C can be treated as the external RADIUS server for other users. Specify the client IP and secret key to make the wireless client choosing VigorAP 1000C as its external RADIUS server.  <b>Client IP</b> – Type the IP address for the user to be authenticated by VigorAP 1000C when the user tries to use VigorAP 1000C as the external RADIUS server.  <b>Secret Key</b> – Type the password for the user to be authenticated by VigorAP 1000C while the user tries to use VigorAP 1000C as the external RADIUS server.  <b>Confirm Secret Key</b> – Type the password again for confirmation. <b>Configure</b> <ul style="list-style-type: none"> <li>● <b>Add</b> – Make a new client with IP and secret key specified on the left boxes.</li> <li>● <b>Cancel</b> – Clear current settings for the client.</li> </ul> <b>Delete Selected</b> – Delete the selected client(s). <b>Delete All</b> – Delete all of the clients.
<b>Backup Radius Cfg</b>	<b>Backup</b> - Click to store the configuration set on this page as a file.
<b>Upload From File</b>	<b>Browse</b> - Click to upload the RADIUS configuration file from the host to VigorAP.  <b>Restore</b> - Click to restore the RADIUS configuration file to VigorAP.

After finishing this web page configuration, please click **OK** to save the settings.

## IV-1-2 Certificate Management

When the local client and remote server are required to make certificate authentication (e.g., Radius EAP-TLS authentication) for wireless connection and avoiding the attack of MITM, a trusted root certificate authority (Root CA) will be used to authenticate the digital certificates offered by both ends.

However, the procedure of applying digital certificate from a trusted root certificate authority is complicated and time-consuming. Therefore, Vigor AP offers a mechanism which allows you to

generate root CA to save time and provide convenience for general user. Later, such root CA generated by DrayTek server can perform the issuing of local certificate.

Root CA can be deleted but not edited. If you want to modify the settings for a Root CA, please delete the one and create another one by clicking Create Root CA.

**RADIUS Setting >> X509 Trusted CA Certificate Configuration**

Name	Subject	Status	Modify
Root CA	---	---	Create Root CA

- Note:**
1. Please setup the "System Maintenance >> Time and Date" correctly before you try to generate a RootCA.
  2. The Time Zone MUST be setup correctly.

Click **Create Root CA** to open the following page. Type or choose all the information that the window request such as subject name, key type, key size and so on.

**RADIUS Setting >> Create Root CA**

Certificate Name	Root CA
<b>Subject Name</b>	
Country (C)	<input type="text"/>
State (S)	<input type="text"/>
Location (L)	<input type="text"/>
Organization (O)	<input type="text"/>
Organization Unit (OU)	<input type="text"/>
Common Name (CN)	<input type="text"/>
Email (E)	<input type="text"/>
<b>Key Type</b>	
	RSA <input type="text"/>
<b>Key Size</b>	
	1024 Bit <input type="text"/>
<b>Apply to Web HTTPS</b>	
	<input type="checkbox"/>

OK Cancel

Available settings are explained as follows:

Item	Description
<b>Subject Name</b>	Type the required information for creating a root CA. Country (C) – Type the country code (two characters) in this box. State (S)/ Location (L)/ Organization (O)/ Organization Unit (OU) /Common Name (CN) - Type the name or information for the root CA with length less than 32 characters.

---

	Email (E) – Type the email address for the root CA with length less than 32 characters.
<b>Key Type</b>	At present, only RSA (an encryption algorithm) is supported by such device.
<b>Key Size</b>	To determine the size of a key to be authenticated, use the drop down list to specify the one you need.
<b>Apply to Web HTTPS</b>	VigorAP needs a certificate to access into Internet via Web HTTPS. Check this box to use the user-defined root CA certificate which will substitute for the original certificate applied by web HTTPS.

---

---

 **Note:**

“Common Name” must be configured with rotuer’s WAN IP or domain name.

---

After finishing this web page configuration, please click **OK** to save the settings. A new root CA will be generated.

## IV-2 Applications

Below shows the menu items for Applications.

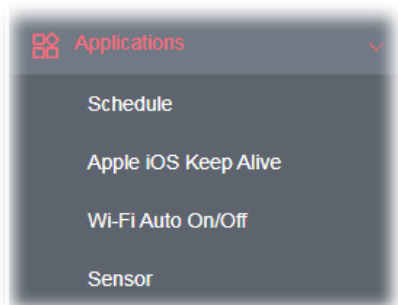

### IV-2-1 Schedule

The VigorAP has a built-in clock which can update itself manually or automatically by means of Network Time Protocols (NTP). As a result, you can not only schedule the AP to dialup to the Internet at a specified time, but also restrict Internet access to certain hours so that users can connect to the Internet only during certain hours, say, business hours. The schedule is also applicable to other functions.

You have to set your time before set schedule. In **System Maintenance>> Time and Date** menu, press **Inquire Time** button to set the VigorAP's clock to current time of your PC. The clock will reset once if you power down or reset the AP. There is another way to set up time. You can inquiry an NTP server (a time server) on the Internet to synchronize the AP's clock. This method can only be applied when the WAN connection has been built up.

Applications >> Schedule

Schedule : Current System Time

| [System time set](#) | [Set to Factory Default](#) |

Active 
  Finished 
  Not reached  
 Index Enable Name Action Time Frequency

OK

Add

Available settings are explained as follows:

Item	Description
<b>Current System Time</b>	Display current system time.
<b>System time set</b>	Click it to open Time and Date page for configuring the time setting.
<b>Set to Factory Default</b>	Click it to return to the factory default setting and remove all the schedule profiles.
<b>Index</b>	Display the sort number of the schedule profile.
<b>Enable</b>	Check it to enable the function of schedule configuration.
<b>Name</b>	Display the name of the schedule.
<b>Action</b>	Display the action adopted by the schedule profile.
<b>Time</b>	Display the time setting of the schedule.

<b>Frequency</b>	Display the frequency of the time schedule.
------------------	---

You can set up to **15** schedules. To add a schedule:

1. Check the box of **Enable Schedule**.
2. Click the **Add** button to open the following web page.

Applications >> Schedule

**Add Schedule**

Enable

Name

Start Date  -  -  ( Year - Month - Day )

Start Time  :  ( Hour : Minute )

Duration Time  :  ( Hour : Minute )

End Time  :  ( Hour : Minute )

Action

WiFi(2.4GHz)  Radio  SSID2  SSID3  SSID4

WiFi(5GHz)  Radio  SSID2  SSID3  SSID4

WiFi(5GHz-2)  Radio  SSID2  SSID3  SSID4

How Often

Weekday  Monday  Tuesday  Wednesday  Thursday  Friday  Saturday  Sunday

**Note:** 1. If we set WiFi schedule "Start Time" and "End Time" at exact same time, AP will execute the schedule without an end time.  
 2. "Internet Pause" will add Mac into ACL, so please make sure ACL isn't full before applying schedule.If ACL policy is "Disable", AP will change it to "Blocked".

Available settings are explained as follows:

Item	Description
<b>Enable</b>	Check to enable such schedule profile.
<b>Name</b>	Enter the name of the schedule profile.
<b>Start Date</b>	Specify the starting date of the schedule.
<b>Start Time</b>	Specify the starting time of the schedule.
<b>Duration Time</b>	Specify the duration (or period) for the schedule. It is available only for the action set with WIFI UP, WIFI Down, or Internet Pause.
<b>End Time</b>	Display the ending time (sum of start time and duration time) of the schedule.
<b>Action</b>	Specify which action should apply the schedule.

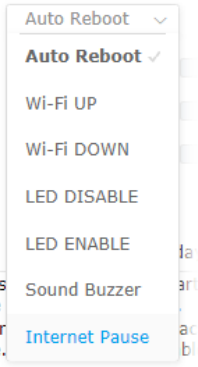
	 <p>In which, you have to specify the device object/device group profile for blocking certain wireless clients when Internet Pause is selected as the Action.</p>
<p><b>WiFi(2.4GHz)/ WiFi(5GHz)/ WiFi(5GHz-2)</b></p>	<p>When <b>Wi-Fi UP</b> or <b>Wi-Fi DOWN</b> is selected as <b>Action</b>, you can check the Radio or SSID 2~4 boxes (2.4GHz, 5GHz and 5GHz-2 respectively) to setup the network based on the schedule profile.</p> <p><b>Note:</b> When Radio is selected, SSID2, SSID3 and SSID4 are not available for choosing, vice versa. Moreover, SSID2, SSID3, and SSID4 are not available for choosing if they are not enabled.</p>
<p><b>How Often</b></p>	<p>Specify how often the schedule will be applied.</p> <p><b>Once</b> -The schedule will be applied just once</p> <p><b>Weekdays</b> -Specify which days in one week should perform the schedule.</p>
<p><b>Weekday</b></p>	<p>Choose and check the day to perform the schedule. It is available when <b>Weekdays</b> is selected as <b>How Often</b>.</p>

- After finishing this web page configuration, please click **OK** to save the settings. A new schedule profile has been created and displayed on the screen.

Applications >> Schedule

Schedule : Current System Time 2020 Mar 2 Mon 10:24:13

| System time set | Set to Factory Default |

Index	Enable	Name	Action	Time	Frequency	Status
1	<input checked="" type="checkbox"/>	Formkt	Auto Reboot		Once	Active

OK

Add

## IV-2-2 Apple iOS Keep Alive

To keep the wireless connection (via Wi-Fi) on iOS device in alive, VigorAP 1000C will send the UDP packets with 5353 port to the specific IP every five seconds.

### Applications >> Apple iOS Keep Alive

Enable Apple iOS Keep Alive

#### Apple iOS Keep Alive:

Apple iOS Keep Alive can keep Wifi connection of iOS device by sending UDP port 5353 packets every 5 seconds.

Index	Apple iOS Keep Alive IP Address	Index	Apple iOS Keep Alive IP Address
<a href="#">1</a>		<a href="#">2</a>	
<a href="#">3</a>		<a href="#">4</a>	
<a href="#">5</a>		<a href="#">6</a>	

OK

Cancel

Available settings are explained as follows:

Item	Description
<b>Enable Apple iOS Keep Alive</b>	Check to enable the function.
<b>Index</b>	Display the setting link. Click the index link to open the configuration page for setting the IP address.
<b>Apple iOS Keep Alive IP Address</b>	Display the IP address.

Click **OK** to save the settings.

## IV-2-3 Wi-Fi Auto On/Off

When VigorAP is able or unable to ping the specified host, the Wi-Fi function will be turned on or off automatically. The purpose of such function is to avoid wireless station roaming to an AP which is unable to access Internet.

Applications >> Wi-Fi Auto On/Off

### Wi-Fi Auto On/Off

Enable Connection Detection

Ping Host

**When the AP is unable to ping the host:**  
 Turn on/off the Wi-Fi automatically when the AP is able/unable to ping the host.  
 When the AP is unable to ping the host:

Wi-Fi:

Sound Buzzer:

LED:

OK

Available settings are explained as follows:

Item	Description
<b>Enable Connection Detection</b>	Check the box to enable such function.
<b>Ping Host</b>	Type an IP address (e.g., 8.8.8.8) or a domain name (e.g., google.com) for testing if the access point is stable or not.
<b>When the AP is unable to ping the host</b>	
<b>Wi-Fi</b>	<b>Off</b> - When VigorAP is unable to ping the host, disconnect the Wi-Fi network. <b>No Change</b> - Wi-Fi network will keep the original state (no matter on or off) even VigorAP is unable to ping the host.
<b>Sound Buzzer</b>	<b>None</b> - When the AP is unable to ping the host, VigorAP will not make any sound. <b>Beep i ~ BeepV</b> - When the AP is unable to ping the host, VigorAP will sound with the selected buzzer type.
<b>LED</b>	<b>Off</b> - When VigorAP is unable to ping the host, the LED (2.4G/5G) will be off automatically. <b>No Change</b> - When VigorAP is unable to ping the host, the LED (2.4G/5G) will keep the original state (no matter on or off).

Click **OK** to save the settings.



## IV-2-4 Sensor

A built-in sensor in this DrayTek AP will help you monitor the server or data communications room environment and notify you if the server room or data communications room is overheating.

During summer in particular, it is important to ensure that your server or data communications equipment are not overheating due to cooling system failures.

The built-in sensor of this VigorAP will continuously monitor the temperature of its environment. When a pre-determined threshold is reached you will be alerted via Syslog.

### Sensor Settings

Applications >> Sensor Setting

Sensor Graph
Sensor Settings

Enable "Sensor Graph"

Alerts once via "Alert Method" when any sensor value is outside of "Alert Criteria" range

**Alert Method**  
 Syslog  Mail

**Alert Criteria**  
 2.4GHz Wi-Fi:  ~   °C  °F , calibration/current val:

**Note:**

1. Wi-Fi temperature is only available when the selected Wi-Fi is enabled

Available settings are explained as follows:

Item	Description
<b>Enable "Sensor Graph"</b>	Check it to display the sensor graph on <b>Applications &gt;&gt; Sensor Setting &gt;&gt; Sensor Graph</b> .
<b>Alerts once/per min via .....</b>	It can determine the time/interval to send an alert message. <b>Once</b> – An alert will be sent out once when the sensor value is outside the range defined in Alert Criteria. <b>Per min.</b> – Alert message will be sent out per minute when the sensor value is outside the range defined in Alert Criteria.
<b>Alert Method</b>	<b>Syslog</b> - The log containing the alarm message will be recorded on Syslog if it is enabled. <b>Mail</b> - The log containing the alarm message will be sent by mail.
<b>Alert Criteria</b>	Alert message will be sent out according to the rules specified in this field. <b>2.4GHz Wi-Fi</b> – The temperature reading for 2.4G Wi-Fi network operation is estimated by using 2.4GHz CPU Wi-Fi module. The built-in sensor of VigorAP contains temperature sensor. Please type the upper limit and lower limit for VigorAP system to send out temperature alert. <b>Calibration / current val-</b> Type values used for correcting the

temperature error.

**C°/F°** - Choose the display unit of the temperature. There are two types for you to choose.

## Temperature Sensor Graph

Below shows an example of temperature graph:

Applications >> Sensor Graph

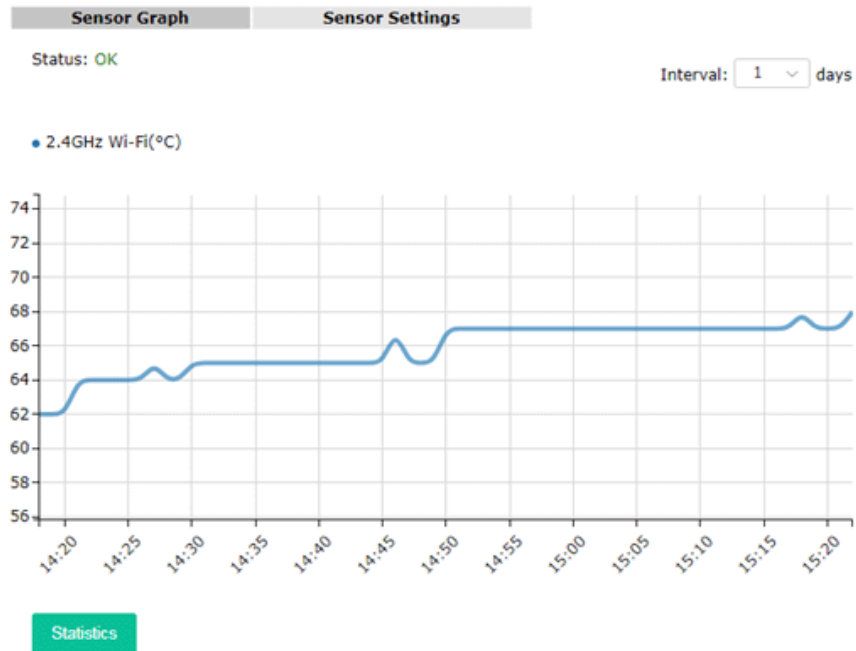

# Chapter V Mobile APP, DrayTek Wireless



# V-1 Introduction of DrayTek Wireless

---

VigorAP 1000C supports Android/iOS APP : DrayTek Wireless. The mobile user can find the APP through Apple Store / Android APP.

After downloading the APP, a mobile user is able to access and login the configuration page of VigorAP. It can be used to set up or check status of VigorAP device in different Operation Mode.

- To access into the VigorAP configured previously, please refer to [\*\*V-2 Select a VigorAP\*\*](#)
- To access into a new installed VigorAP, please refer to [\*\*V-3 Quick Start Wizard\*\*](#)

---

## Note:

Before using the DrayTek Wireless APP, please **ENABLE** your Wi-Fi feature first. Then, select the Wi-Fi network with Vigor access point(s) connected physically.

---

It is not necessary to connect to VigorAP physically. The mobile user must connect to one network with the same subnet as the VigorAP.

## V-2 Select a VigorAP

1. Run DrayTek Wireless APP.

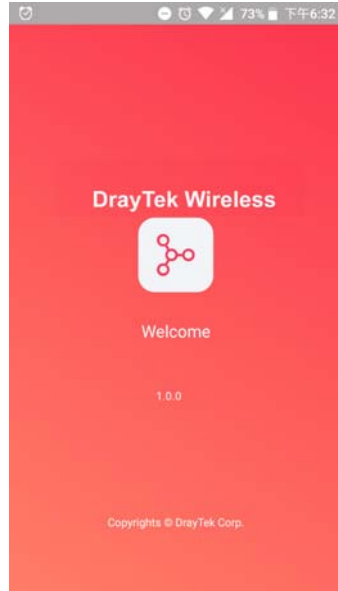

2. Choose one AP in the network by clicking the inverted triangle icon to open a drop down list.

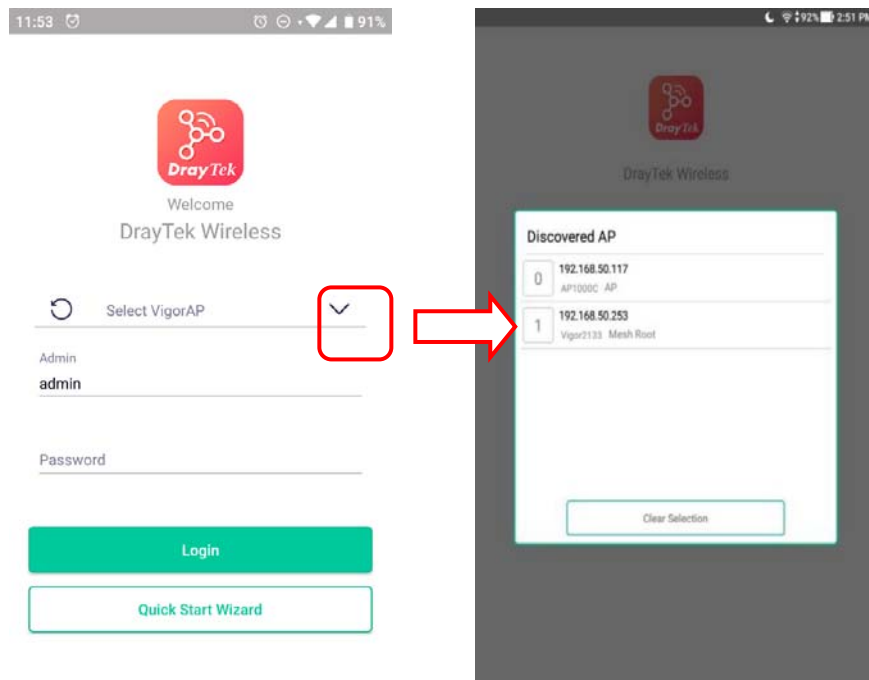

Available VigorAP devices with Model Name, IP and Operation mode of VigorAP found by DrayTek Wireless APP will be listed under **Discovered VigorAP**. Choose one of the devices to login (or use Quick Start Wizard function).

If no AP is found, Quick Start Wizard will start with Wi-Fi connection or start with wizard procedure directly.

# V-3 Quick Start Wizard

Quick Start Wizard in Wireless APP is useful for connecting an new installed AP and configuring with different Operation Mode.

## How to create a Mesh Group?

1. Click **Quick Start Wizard**.

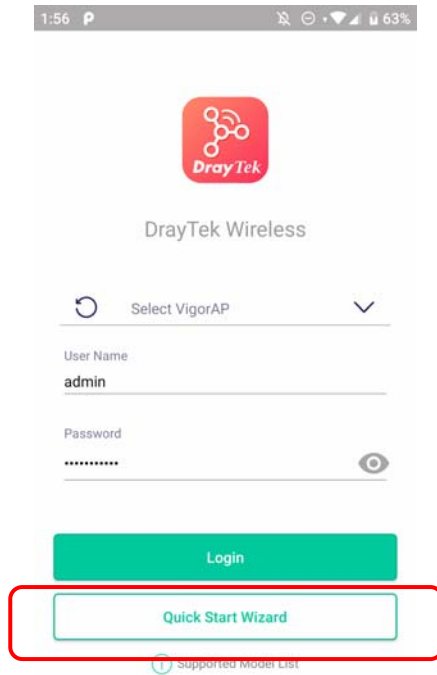

2. Under Quick Start Wizard, there are two methods to locate a mesh root, Search and Scan,
  - Click **Scan** to scan the QR code printed on VigorAP packaging box to connect the designated VigorAP.

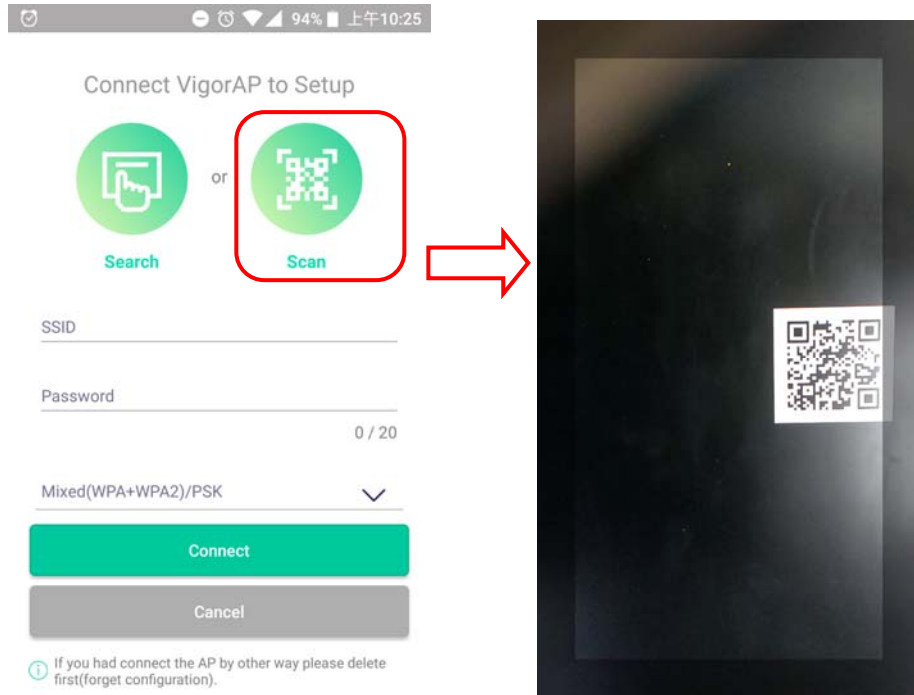

- Or, click **Search**. When the searching result appears, choose one of the AP devices to connect.

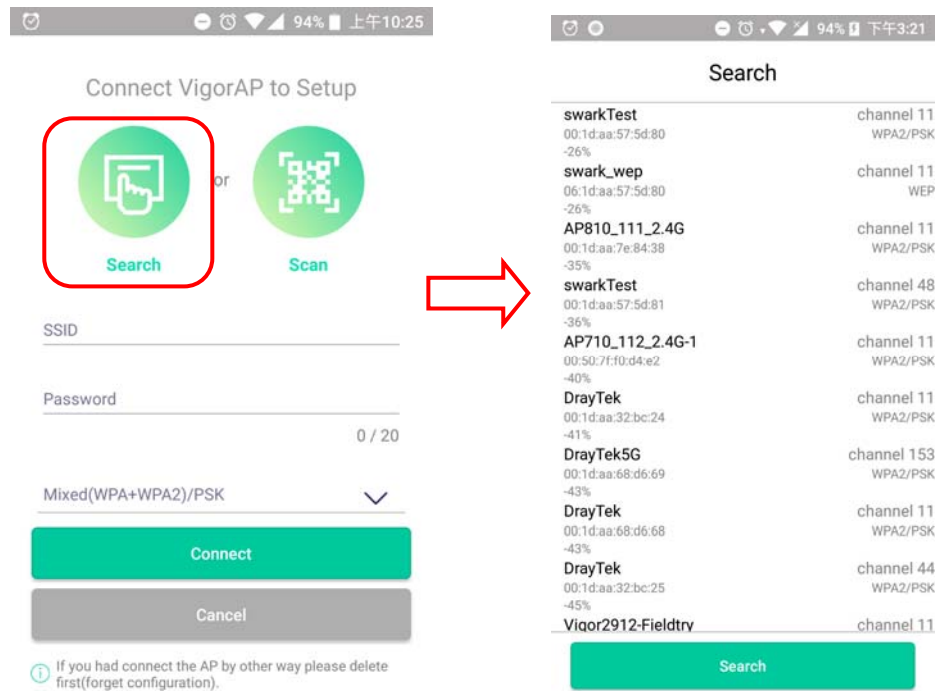

- When the following page appears, enter the password for the VigorAP device. Then, click **Connect**.

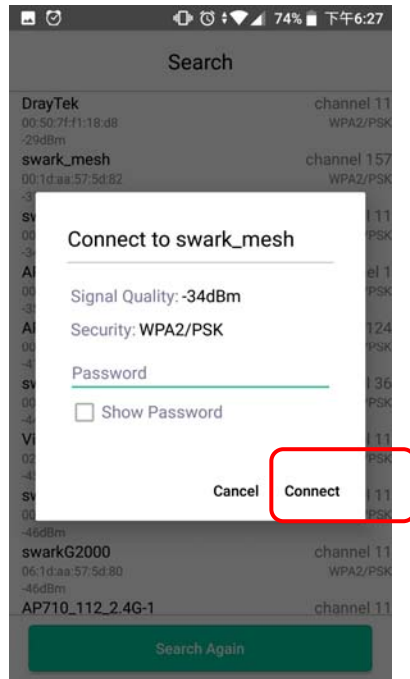

- When the connection is successful, click **Next**. Then, set Operation Mode of VigorAP as **Mesh Root** and click **Next**.

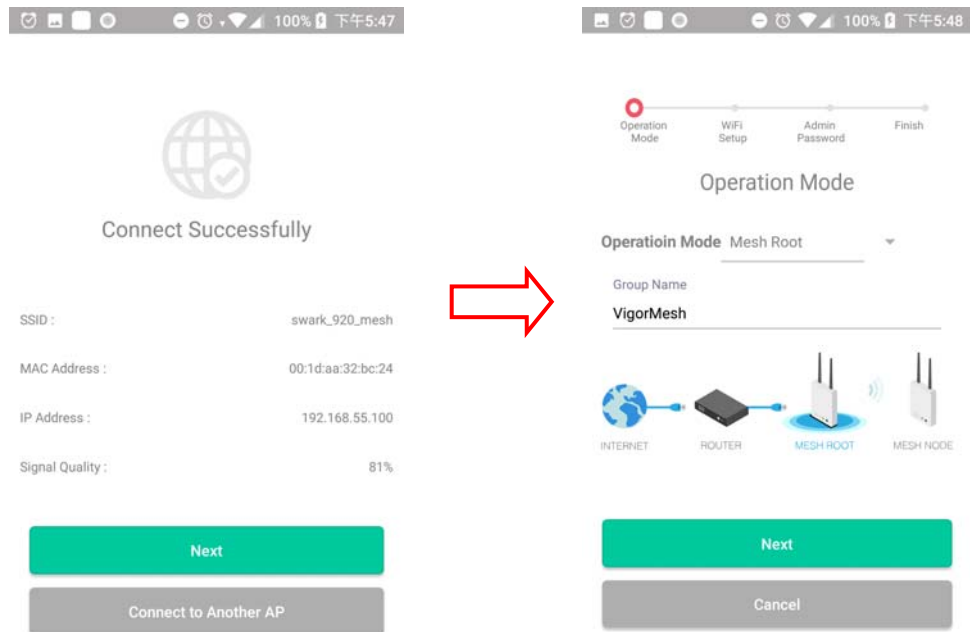



5. In the following page, set the WiFi Name (SSID) and WiFi Password for your network. You can also enable 2nd SSID by enabling the function of 2nd WiFi. Then, click **Next**.

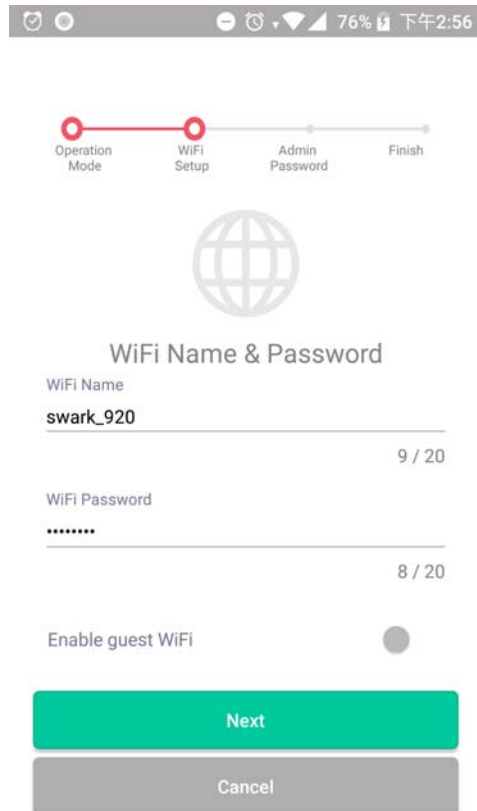

Operation Mode WiFi Setup Admin Password Finish

WiFi Name & Password

WiFi Name  
swark\_920  
9 / 20

WiFi Password  
.....  
8 / 20

Enable guest WiFi

Next

Cancel

6. Change the default admin password for the network security and click **Next**.

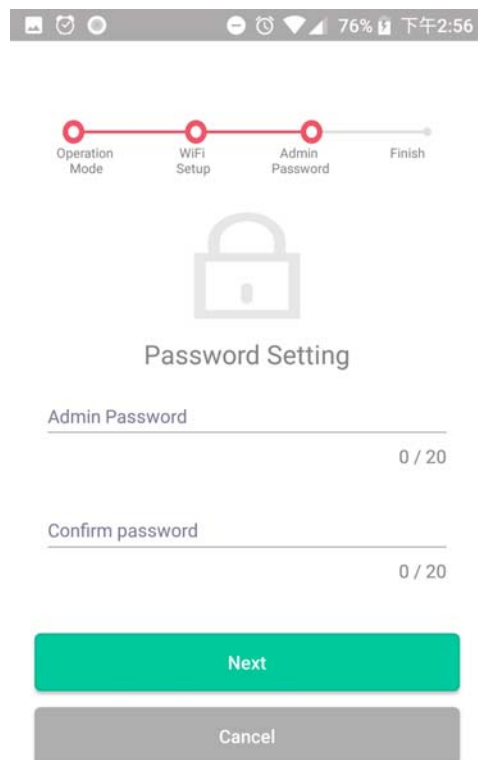

Operation Mode WiFi Setup Admin Password Finish

Password Setting

Admin Password  
0 / 20

Confirm password  
0 / 20

Next

Cancel

7. In the page of **Check and Apply**, click **Finish** to apply the settings to the specified VigorAP.

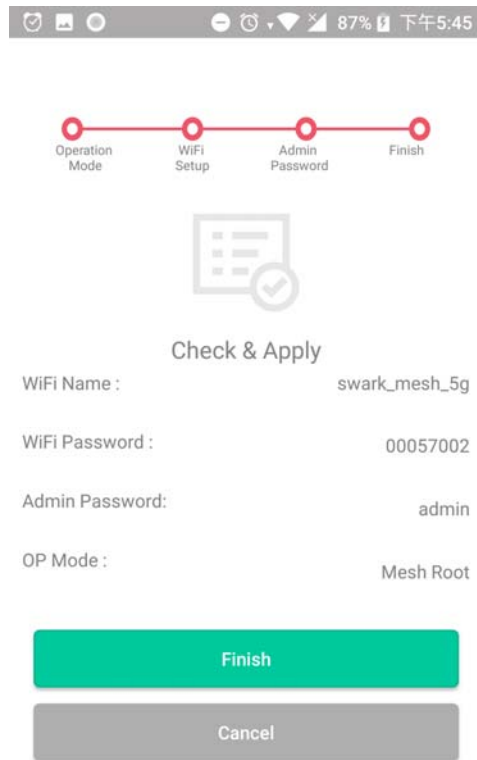

8. After sending configuration to VigorAP, it will take some time to take effect. DrayTek Wireless APP will try to reconnect to wireless network again. Please wait for a while here.

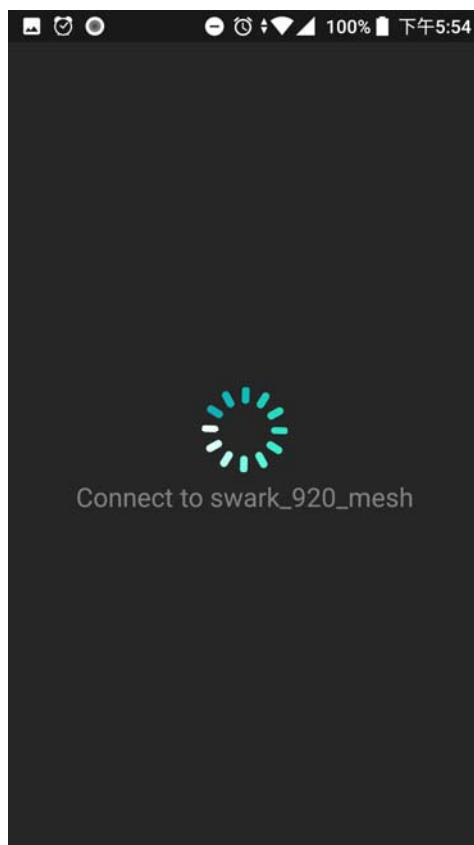

9. Now, the VigorAP has been set as Mesh Root. You can search several Mesh Nodes which do not belong to any other mesh group by clicking **Next**.

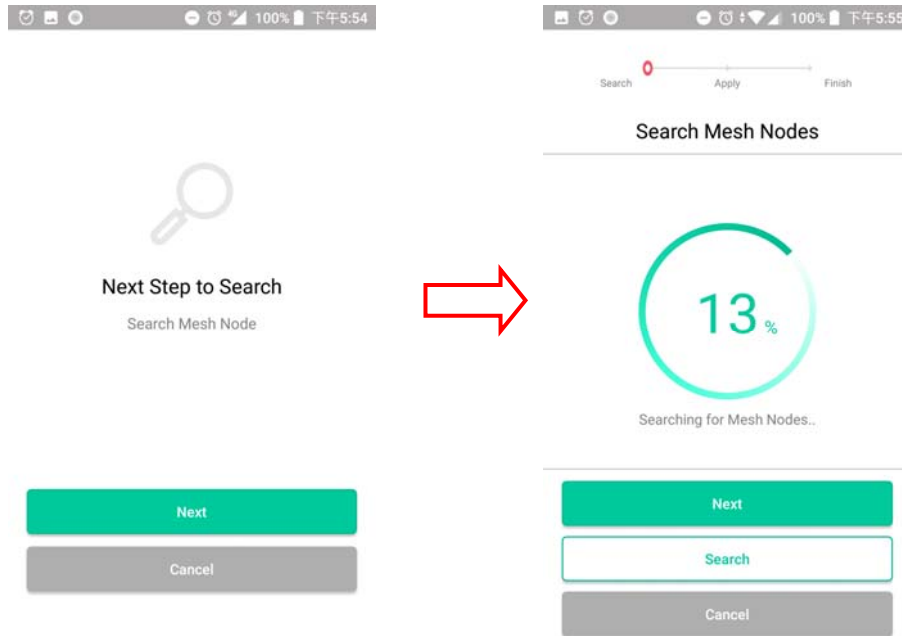

Or, click **Cancel** to return to the home page. Then, click **Add Nodes** to search several Mesh Nodes which do not belong to any other mesh group.

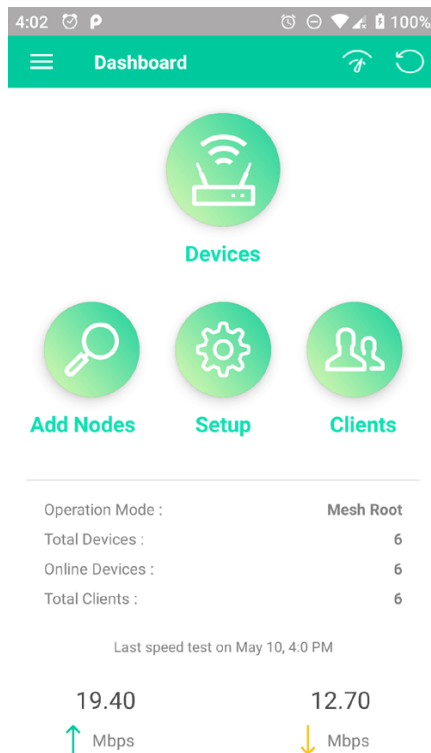

10. Later, available VigorAP devices will be shown on the page. Choose the Mesh Node you want to add and give a device name (e.g., VigorAP920R) for it. The selected mesh node(s) will be grouped under such mesh root. Click **Next**.

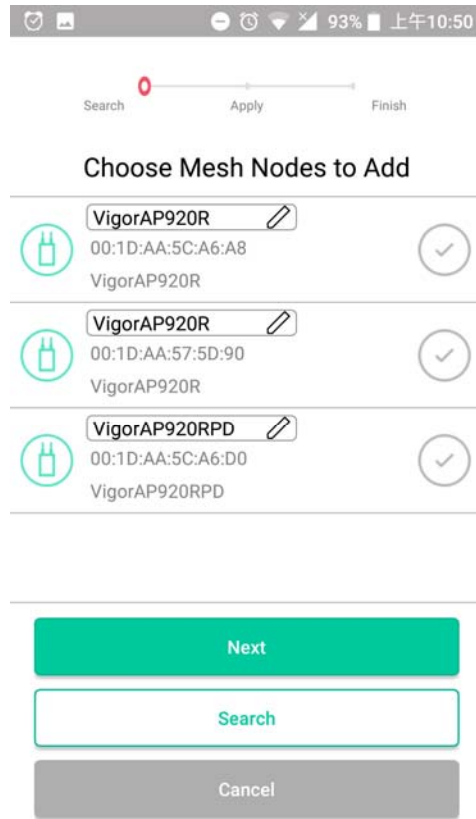

11. The following page displays the total number of mesh nodes selected. Click **Apply**.

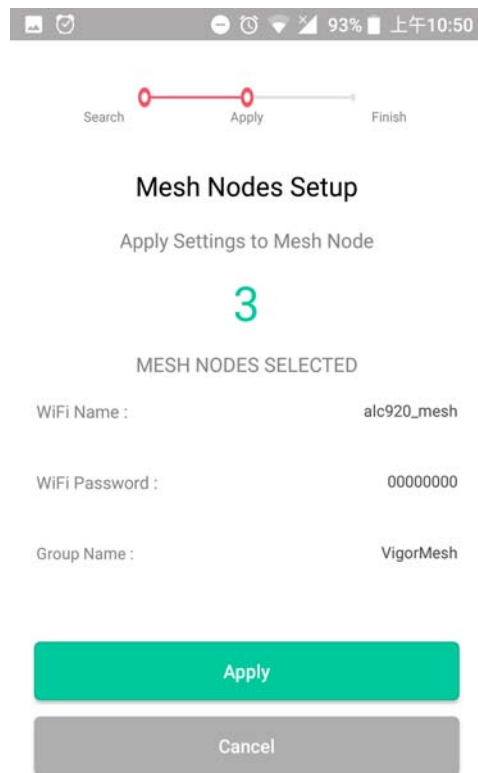

12. Wait until the mesh root applies general configuration to the mesh nodes.



13. Later, current status of the mesh node(s) will be shown on the following page. Click **Finish**.



14. Now, the main page of VigorAP APP will be displayed as follows.

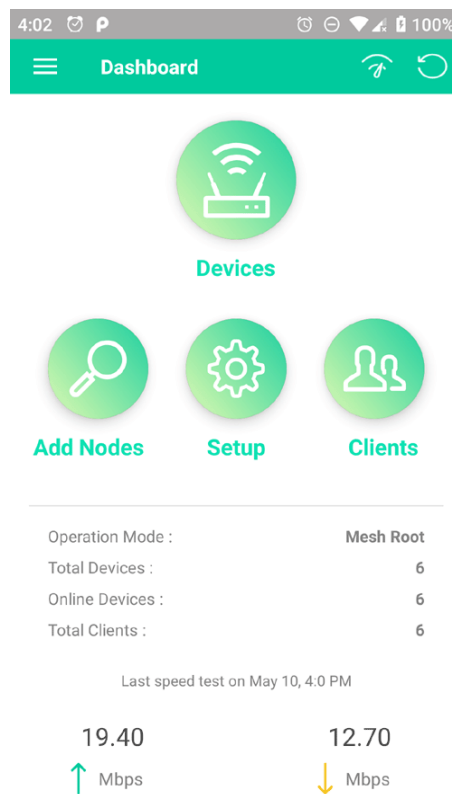

# V-4 Login

The main page of VigorAP APP will be different slightly according to the operation mode of VigorAP.

After login to one AP with **Mesh Root**, the major information will be shown as follows:

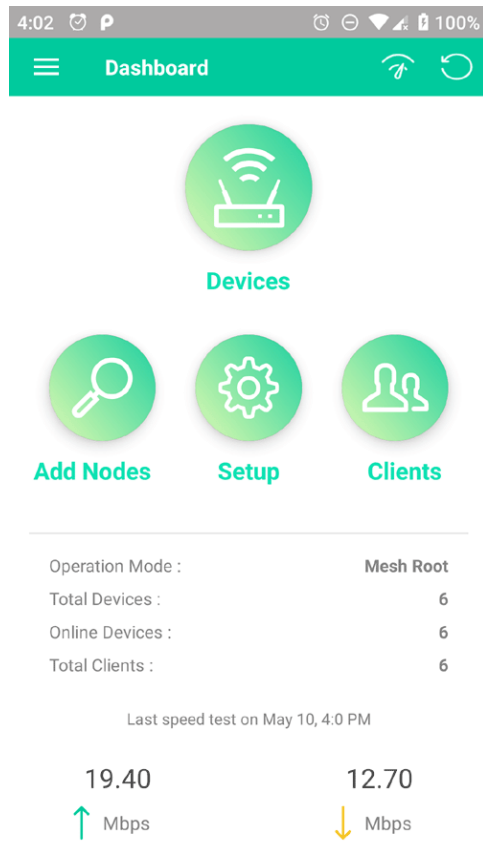

After login to one AP with **AP mode**, the major information will be shown as follows:

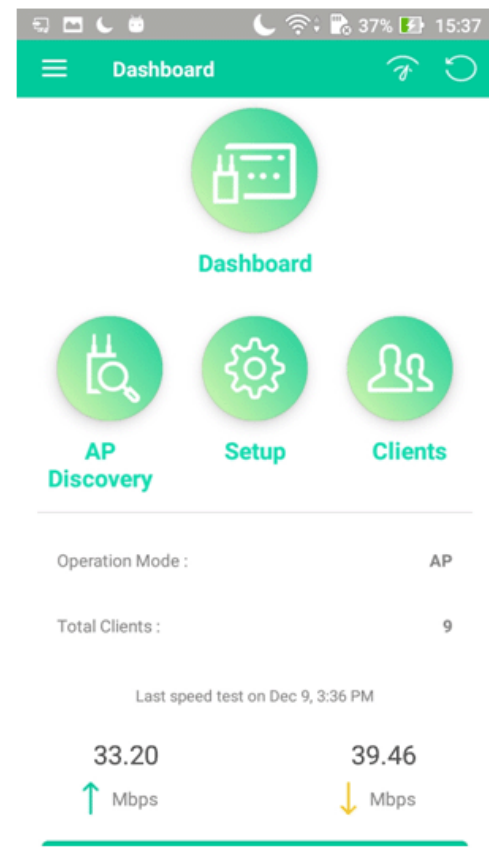

Available settings are explained as follows:

Item	Description
<b>Devices / Dashboard</b>	<p><b>Dashboard</b> - The dashboard is designed with Responsive Web Design. You can click <b>Dashboard</b> to connect to the selected VigorAP WUI.</p> <p><b>Devices</b> - All of the devices (mesh root and mesh nodes) controlled by the mesh group will be shown on this page with hop number. One mesh group contains up to eight devices.</p>

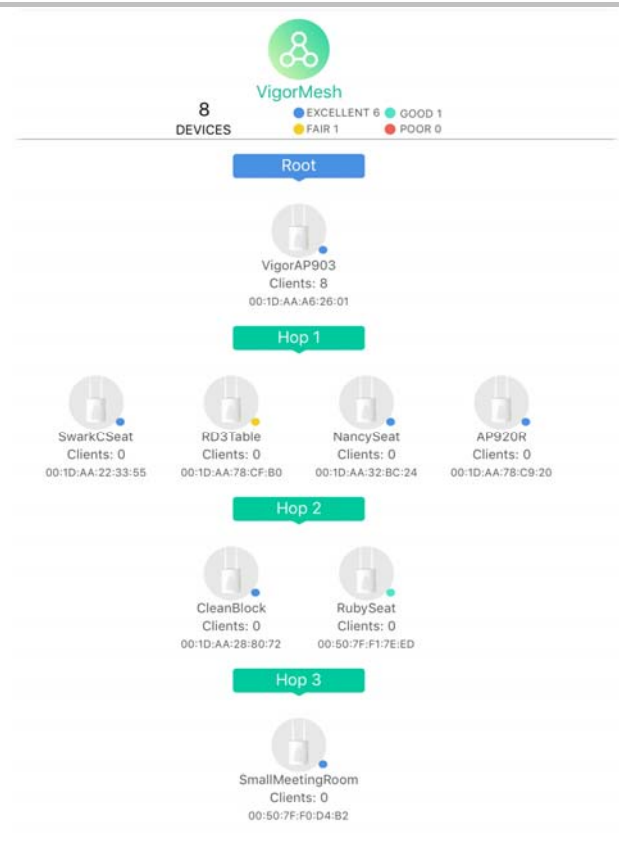

**Add Nodes / AP Discovery**

**Add Nodes** – Click it to add a new mesh node to this mesh group.  
**AP Discovery** – Click it to search another access point.

**Setup**

Click it to configure TR069, Manage and WLAN settings for the connected VigorAP.



**Setup Devices**



**TR069**





**Manage**



**WLAN**



<p><b>Clients</b></p>	<p>Displays general information for all clients in Mesh Group or all clients connected to the selected AP (non-mesh device).</p> 
<p><b>Operation Mode</b></p>	<p>Display the operation mode (e.g., Mesh Root, AP, Mesh Node) of this AP.</p>
<p><b>Total Devices</b></p>	<p>Display the number of the total devices grouped under this mesh group.</p>
<p><b>Online Devices</b></p>	<p>Display current online devices grouped under this mesh group.</p>
<p><b>Total Clients</b></p>	<p>Display the number of the total clients connected to the mesh group or the selected AP (non-mesh device).</p>
<p> <b>(Speed test)</b></p>	<p>Click it to make a speed test for the mesh group / AP.</p>
<p><b>Logout</b></p>	<p>Exit this APP.</p>

This page is left blank.

# Chapter VI Troubleshooting



## VI-1 Diagnostics

---

This section will guide you to solve abnormal situations if you cannot access into the Internet after installing the router and finishing the web configuration. Please follow sections below to check your basic installation status stage by stage.

- Checking if the hardware status is OK or not.
- Checking if the network connection settings on your computer are OK or not.
- Pinging the router from your computer.
- Checking if the ISP settings are OK or not.
- Backing to factory default setting if necessary.

If all above stages are done and the router still cannot run normally, it is the time for you to contact your dealer or DrayTek technical support for advanced help.

Diagnostics tools provide a useful way to **view** or **diagnose** the status of your VigorAP 1000C.

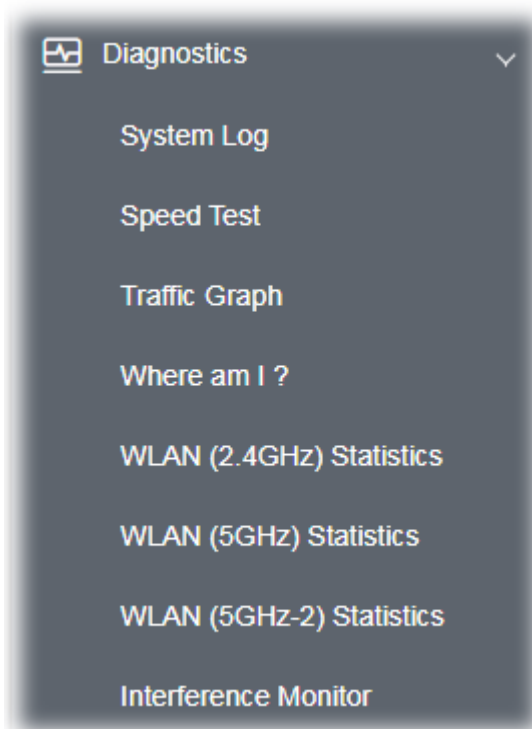

## VI-1-1 System Log

At present, only **System Log** is offered.

Diagnostics >> System Log

System Log Information

| Clear | Refresh |  Line wrap |

```
Mar 2 09:20:29 kernel: [330839.940723] ol_scan_unregister_event_handler: Failed to unregi
Mar 2 09:20:29 kernel: [330839.940723]
Mar 2 09:20:29 kernel: [330839.950384] osif_vap_stop: Scan in progress.. Cancelling it. vap
Mar 2 09:20:29 kernel: [330839.975642] br0: port 7(ath90) entered forwarding state
Mar 2 09:20:29 kernel: [330839.986752] Auto Channel Select :
Mar 2 09:20:29 kernel: [330839.986767] 100 104
Mar 2 09:20:29 kernel: [330839.986783] 108 112
Mar 2 09:20:29 kernel: [330839.986794] 116 120
Mar 2 09:20:29 kernel: [330839.986805] 124 128
Mar 2 09:20:29 kernel: [330839.988500] br0: port 7(ath90) entered disabled state
Mar 2 09:20:30 kernel: [330840.815668] br0: port 8(ath91) entered forwarding state
Mar 2 09:20:31 kernel: [330842.023482] osif_vap_init: Scan in progress.. Cancelling it. vap:
Mar 2 09:20:31 kernel: [330842.031806] osif_vap_init: Failed to cancel Scan!
Mar 2 09:20:31 kernel: [330842.066917] br0: port 7(ath90) entered forwarding state
Mar 2 09:20:31 kernel: [330842.071313] br0: port 7(ath90) entered forwarding state
Mar 2 09:20:31 kernel: [330842.077461] 8021q: adding VLAN 0 to HW filter on device ath90
Mar 2 09:20:31 kernel: [330842.158674] ol_scan_unregister_event_handler: Failed to unregi
```

## VI-1-2 Speed Test

Click the **Start** button on the page to test the speed. Such feature can help you to find the best installation place for Vigor AP.

Diagnostics >> Speed Test

Speed Test

Welcome to VigorAP1000C Speed Test.

This test allows you to find out the best place for VigorAP1000C. You can execute the speed test at different places of the building and select the best location for it. The performance test result is only for your reference.

Start

## VI-1-3 Traffic Graph

Click **Traffic Graph** to open the web page. Choose one of the managed Access Points, LAN-A or LAN-B, daily or weekly for viewing data transmission chart. Click **Refresh** to renew the graph at any time.

Diagnostics >> Traffic Graph

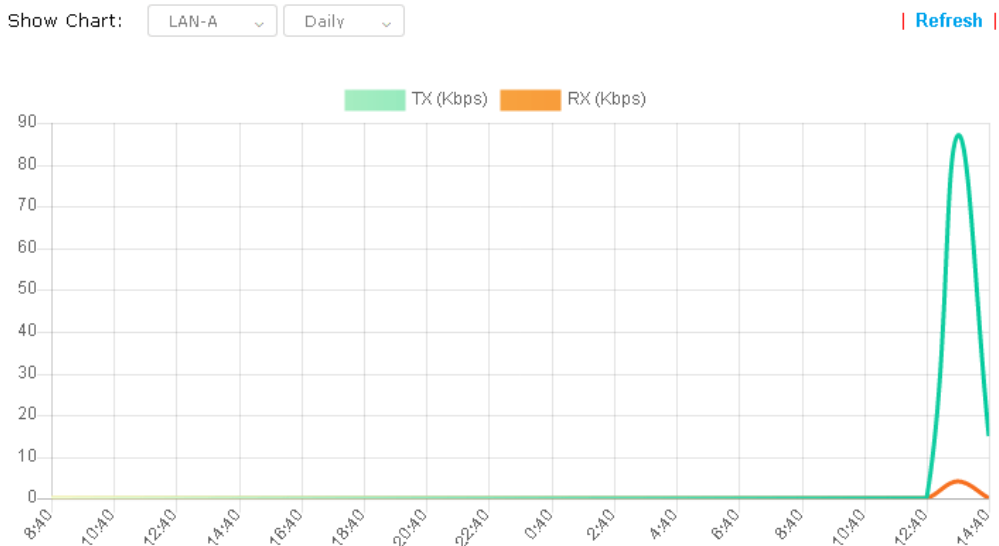

The horizontal axis represents time; the vertical axis represents the transmission rate (in kbps).

## VI-1-4 Where am I

This function is useful for the administrator to locate the access points to build the best signal transmitting position for multiple access points.

Diagnostics >> Where am I ?

Where am I ?

Welcome to VigorAP1000C Where am I ?

The buzzer will sound when the "Sound" button is clicked. This is useful for network administrators to locate the access point.

Sound  for  second(s)

Available parameters are explained as follows:

Item	Description
<b>Sound</b>	Use the drop down list to specify a special sound for such access point.
<b>for XX seconds</b>	Set the duration time of the beep sound.

<b>Sound</b>	Activate the buzzer of the access point.
<b>Stop</b>	Terminate the buzzer of the access point.

## VI-1-5 WLAN (2.4GHz) Statistics

Such page is used for debug by RD only.

Diagnostics >> WLAN (2.4GHz) Statistics

Auto-Refresh

Refresh

Tx Data Packets	0	Rx Data Packets	0
Tx Data Bytes	0	Rx Data Bytes	0
Average Tx Rate (kbps)	No Station	Average Rx Rate (kbps)	No Station
Tx Unicast Data Packets	0	Rx PHY errors	0
Tx Multi/Broadcast Data Packets	0	Rx CRC errors	737
Tx failures	0	Rx MIC errors	0
		Rx Decryption errors	0
		Rx errors	0

	SSID1 (DrayTek-04F2C8)	SSID2 (marketing)	SSID3 (N/A)	SSID4 (N/A)
Tx Data Packets	0	0	N/A	N/A
Tx Data Bytes	0	0	N/A	N/A
Tx Data BytesTx Data Payload Bytes	0	0	N/A	N/A
Rx Data Packets	0	0	N/A	N/A
Rx Data Bytes	0	0	N/A	N/A
Rx Data Payload Bytes	0	0	N/A	N/A
Tx Unicast Data Packets	0	0	N/A	N/A
Tx Multi/Broadcast Data Packets	0	0	N/A	N/A
Average Tx Rate (kbps)	No Station	No Station	N/A	N/A
Average Rx Rate (kbps)	No Station	No Station	N/A	N/A
Rx errors	0	0	N/A	N/A
Tx failures	0	0	N/A	N/A

## VI-1-6 WLAN (5GHz) Statistics

Such page is used for debug by RD only.

Diagnostics >> WLAN (5GHz) Statistics

Auto-Refresh

Refresh

Tx Data Packets	0	Rx Data Packets	0
Tx Data Bytes	0	Rx Data Bytes	0
Average Tx Rate (kbps)	No Station	Average Rx Rate (kbps)	No Station
Tx Unicast Data Packets	0	Rx PHY errors	0
Tx Multi/Broadcast Data Packets	0	Rx CRC errors	12673
Tx failures	0	Rx MIC errors	0
		Rx Decryption errors	0
		Rx errors	0

	SSID1 (DrayTek-04F2C8)	SSID2 (marketing)	SSID3 (N/A)	SSID4 (N/A)
Tx Data Packets	0	0	N/A	N/A
Tx Data Bytes	0	0	N/A	N/A
Tx Data BytesTx Data Payload Bytes	0	0	N/A	N/A
Rx Data Packets	0	0	N/A	N/A
Rx Data Bytes	0	0	N/A	N/A
Rx Data Payload Bytes	0	0	N/A	N/A
Tx Unicast Data Packets	0	0	N/A	N/A
Tx Multi/Broadcast Data Packets	0	0	N/A	N/A
Average Tx Rate (kbps)	No Station	No Station	N/A	N/A
Average Rx Rate (kbps)	No Station	No Station	N/A	N/A
Rx errors	0	0	N/A	N/A
Tx failures	0	0	N/A	N/A



## VI-1-7 WLAN (5GHz-2) Statistics

Such page is used for debug by RD only.

Diagnostics >> WLAN (5GHz-2) Statistics

Auto-Refresh

Refresh

Tx Data Packets	0	Rx Data Packets	0
Tx Data Bytes	0	Rx Data Bytes	0
Average Tx Rate (kbps)	No Station	Average Rx Rate (kbps)	No Station
Tx Unicast Data Packets	0	Rx PHY errors	901493
Tx Multi/Broadcast Data Packets	0	Rx CRC errors	7430
Tx failures	0	Rx MIC errors	0
		Rx Decryption errors	0
		Rx errors	0

	SSID1 (DrayTek-04F2C8)	SSID2 (marketing)	SSID3 (N/A)	SSID4 (N/A)
Tx Data Packets	0	0	N/A	N/A
Tx Data Bytes	0	0	N/A	N/A
Tx Data BytesTx Data Payload Bytes	0	0	N/A	N/A
Rx Data Packets	0	0	N/A	N/A
Rx Data Bytes	0	0	N/A	N/A
Rx Data Payload Bytes	0	0	N/A	N/A
Tx Unicast Data Packets	0	0	N/A	N/A
Tx Multi/Broadcast Data Packets	0	0	N/A	N/A
Average Tx Rate (kbps)	No Station	No Station	N/A	N/A
Average Rx Rate (kbps)	No Station	No Station	N/A	N/A
Rx errors	0	0	N/A	N/A
Tx failures	0	0	N/A	N/A

## VI-1-8 Interference Monitor

As an interference detector, VigorAP can detect all of the environmental interference factors for certain channel used or for all of the wireless channels.

### Current Channel

The analysis page with information about wireless band, channel, transmission power, bandwidth, wireless mode, and country code chosen will be displayed on this page completely based on the wireless band (2.4G or 5G or 5G-2) selected. Also, channel status can be seen easily from this page.

Diagnostics >> Interference Monitor

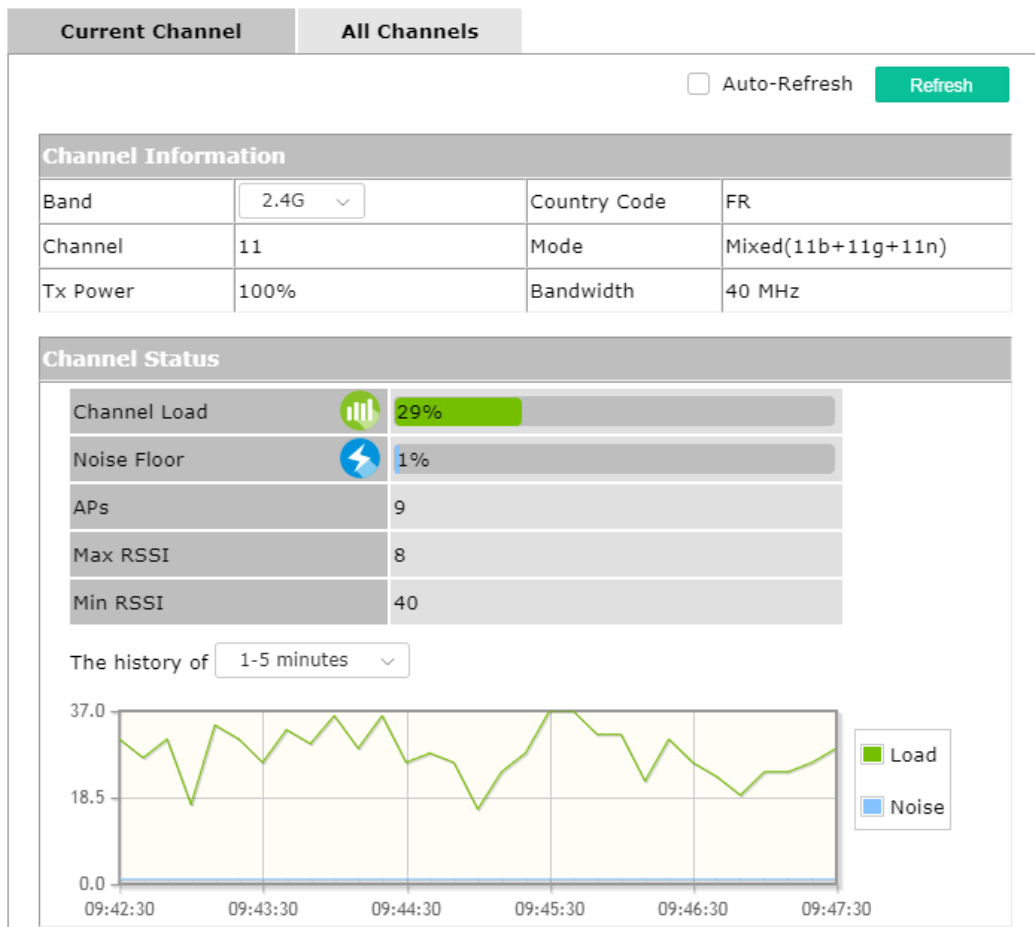

## All Channels

This page displays the utilization and energy result for all channels based on 2.4G/5G. Click **Refresh** to get the newly update interference situation.

Diagnostics >> Interference Monitor

**Current Channel** | **All Channels**

Band:

Recommended channel for usage: 6

Channel	Channel Load	Noise Floor	APs
1	35%	1%	6
2	23%	1%	0
3	16%	3%	5
4	11%	1%	0
5	18%	1%	0
6	20%	1%	4
7	9%	1%	0
8	5%	1%	0
9	17%	1%	2
10	36%	1%	0
11	47%	1%	14
12	29%	1%	0
13	8%	1%	1

Last updated: 11/01 09:49:00

**Note:** During the scanning process, no station is allowed to connect with the AP.

## VI-1-9 Support Area

When you click **Support Area**, you will be guided to visit [www.draytek.com](http://www.draytek.com) and open the corresponding pages directly.

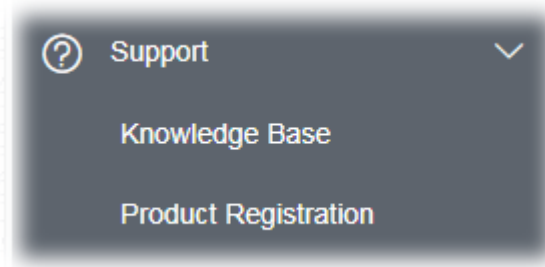

## VI-2 Checking the Hardware Status

---

Follow the steps below to verify the hardware status.

1. Check the power line and cable connections.  
Refer to “**I-2 Hardware Installation**” for details.
2. Power on the modem. Make sure the **POWER LED**, **ACT LED** and **LAN LED** are bright.
3. If not, it means that there is something wrong with the hardware status. Simply back to “**I-2 Hardware Installation**” to execute the hardware installation again. And then, try again.

# VI-3 Checking the Network Connection Settings

Sometimes the link failure occurs due to the wrong network connection settings. After trying the above section, if the link is still failed, please do the steps listed below to make sure the network connection settings is OK.

## VI-3-1 For Windows

**Note:**

The example is based on Windows 7 (Professional Edition). As to the examples for other operation systems, please refer to the similar steps or find support notes in [www.draytek.com](http://www.draytek.com).

1. Open **All Programs>>Getting Started>>Control Panel**. Click **Network and Sharing Center**.



2. In the following window, click **Change adapter settings**.

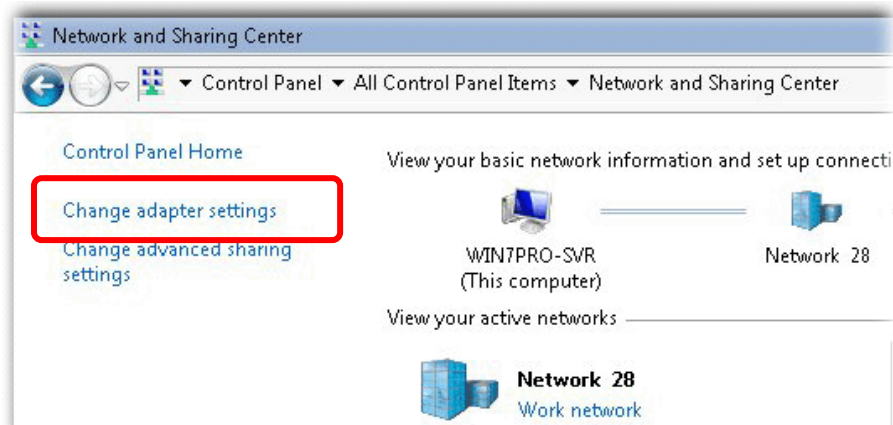

- Icons of network connection will be shown on the window. Right-click on **Local Area Connection** and click on **Properties**.

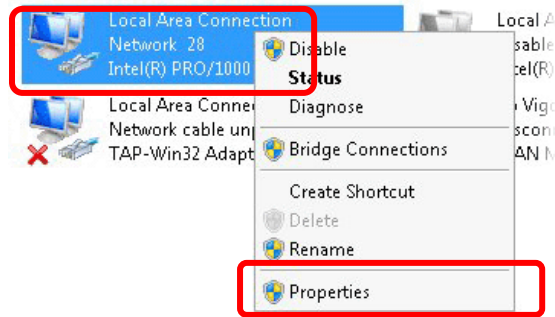

- Select **Internet Protocol Version 4 (TCP/IP)** and then click **Properties**.

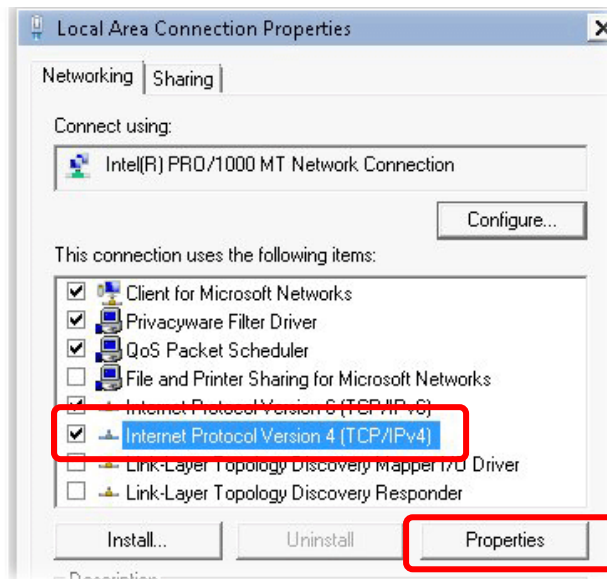

- Select **Obtain an IP address automatically** and **Obtain DNS server address automatically**. Finally, click **OK**.

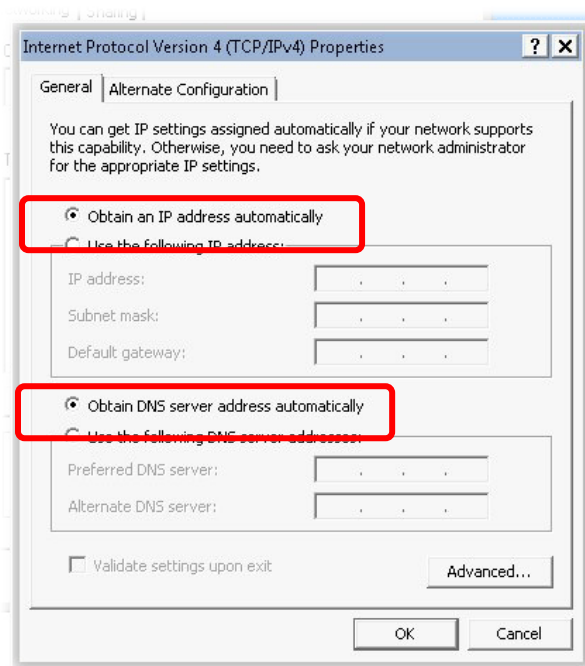

## VI-3-2 For Mac Os

1. Double click on the current used Mac Os on the desktop.
2. Open the **Application** folder and get into **Network**.
3. On the **Network** screen, select **Using DHCP** from the drop down list of Configure IPv4.

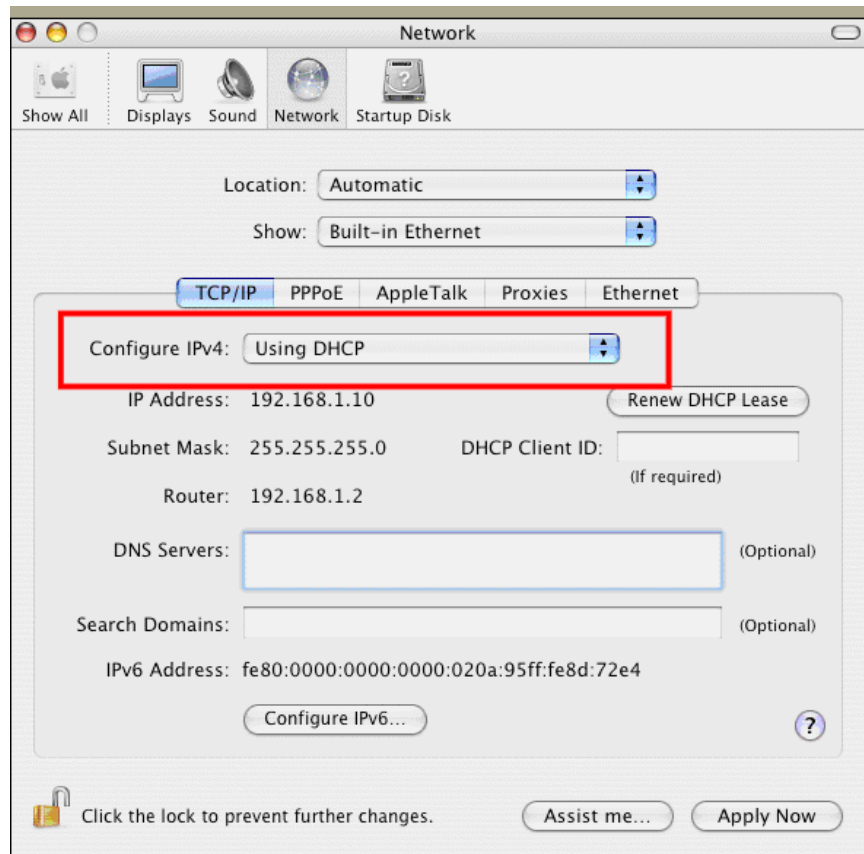



## VI-4 Pinging the Device

---

The default gateway IP address of the modem is 192.168.1.2. For some reason, you might need to use “ping” command to check the link status of the modem. **The most important thing is that the computer will receive a reply from 192.168.1.2.** If not, please check the IP address of your computer. We suggest you setting the network connection as **get IP automatically**. (Please refer to the section V-2)

Please follow the steps below to ping the modem correctly.

### VI-4-1 For Windows

1. Open the **Command Prompt** window (from **Start menu> Run**).
2. Type **command** (for Windows 95/98/ME) or **cmd** (for Windows NT/2000/XP/Vista/7). The DOS command dialog will appear.

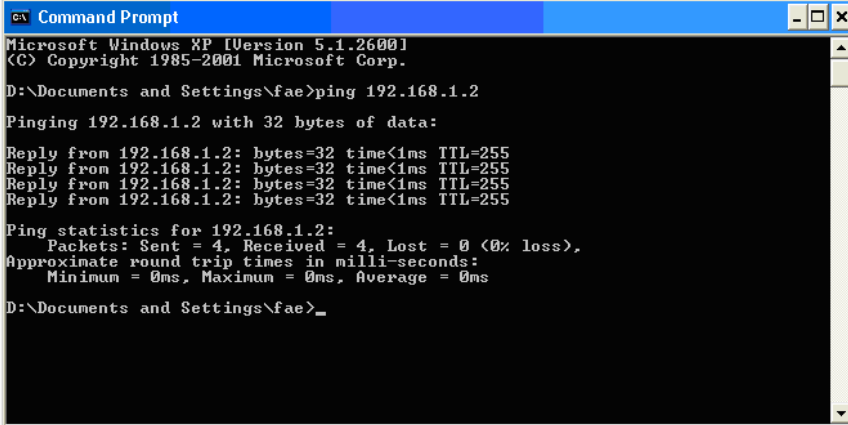

```
ex Command Prompt
Microsoft Windows XP [Version 5.1.2600]
(C) Copyright 1985-2001 Microsoft Corp.
D:\Documents and Settings\fae>ping 192.168.1.2
Pinging 192.168.1.2 with 32 bytes of data:
Reply from 192.168.1.2: bytes=32 time<1ms TTL=255
Reply from 192.168.1.2: bytes=32 time<1ms TTL=255
Reply from 192.168.1.2: bytes=32 time<1ms TTL=255
Reply from 192.168.1.2: bytes=32 time<1ms TTL=255

Ping statistics for 192.168.1.2:
    Packets: Sent = 4, Received = 4, Lost = 0 (0% loss),
    Approximate round trip times in milli-seconds:
        Minimum = 0ms, Maximum = 0ms, Average = 0ms
D:\Documents and Settings\fae>_
```

3. Type ping 192.168.1.2 and press [Enter]. If the link is OK, the line of “**Reply from 192.168.1.2:bytes=32 time<1ms TTL=255**” will appear.
4. If the line does not appear, please check the IP address setting of your computer.

### VI-4-2 For Mac Os (Terminal)

1. Double click on the current used Mac Os on the desktop.
2. Open the **Application** folder and get into **Utilities**.
3. Double click **Terminal**. The Terminal window will appear.
4. Type **ping 192.168.1.2** and press [Enter]. If the link is OK, the line of “**64 bytes from 192.168.1.2: icmp\_seq=0 ttl=255 time=xxxx ms**” will appear.

```
Terminal — bash — 80x24
Last login: Sat Jan  3 02:24:18 on ttys1
Welcome to Darwin!
Vigor10:~ draytek$ ping 192.168.1.1
PING 192.168.1.1 (192.168.1.1): 56 data bytes
64 bytes from 192.168.1.1: icmp_seq=0 ttl=255 time=0.755 ms
64 bytes from 192.168.1.1: icmp_seq=1 ttl=255 time=0.697 ms
64 bytes from 192.168.1.1: icmp_seq=2 ttl=255 time=0.716 ms
64 bytes from 192.168.1.1: icmp_seq=3 ttl=255 time=0.731 ms
64 bytes from 192.168.1.1: icmp_seq=4 ttl=255 time=0.72 ms
^C
--- 192.168.1.1 ping statistics ---
5 packets transmitted, 5 packets received, 0% packet loss
round-trip min/avg/max = 0.697/0.723/0.755 ms
Vigor10:~ draytek$
```

# VI-5 Backing to Factory Default Setting

Sometimes, a wrong connection can be improved by returning to the default settings. Try to reset the modem by software or hardware.

**i Warning:**

After pressing **factory default setting**, you will lose all settings you did before. Make sure you have recorded all useful settings before you pressing. The password of factory default is null.

## VI-5-1 Software Reset

You can reset the modem to factory default via Web page.

Go to **System Maintenance** and choose **Reboot System** on the web page. The following screen will appear. Choose **Using factory default configuration** and click **OK**. After few seconds, the modem will return all the settings to the factory settings.

**System Maintenance >> Reboot System**

### Reboot System

**Do You want to reboot your AP ?**

Using current configuration

Using factory default configuration

OK

## VI-5-2 Hardware Reset

While the modem is running, press the **Factory Reset** button and hold for more than 5 seconds. When you see the **ACT** LED blinks rapidly, please release the button. Then, the modem will restart with the default configuration.

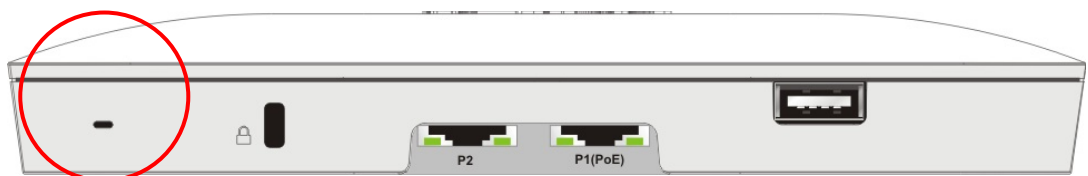

After restore the factory default setting, you can configure the settings for the modem again to fit your personal request.

## VI-6 Contacting DrayTek

---

If the modem still cannot work correctly after trying many efforts, please contact your dealer for further help right away. For any questions, please feel free to send e-mail to [support@draytek.com](mailto:support@draytek.com).

# Index

## 8

802.11n, 41

## A

Access Control, 46

Action, 129

Advanced Setting, 49

AES, 30

Airtime Fairness, 53

Antenna, 49

AP Discovery, 51

AP Management, 107

AP Mode, 39, 70, 83

AP Operation Mode, 17

APM Log, 108

Apple iOS Keep Alive, 131

Applications, 128

Auth Mode, 48

Authentication Client, 125

Authentication Type, 125

Auto Adjustment, 53

Auto Channel Filtered Out List, 50

Auto Logout, 13

Auto Provision, 107

## B

Band Steering, 59

Bandwidth Limit, 18, 21, 28

Bandwidth Management, 52

Black List, 109

## C

Central AP Management, 107

Certificate Management, 125

Changing Password, 14

Channel, 41, 84

Channel Width, 49

Client IP, 125

Client PinCode, 48

Client's MAC Address, 109

Configuration Backup, 97, 98

Connection Time, 56

Connection Type, 85

Country Code, 50

## D

Data Flow Monitor, 154

Default Gateway, 85

Detection, 112, 118, 119

DHCP Client, 87

DHCP server, 11

Download Limit, 53

## E

EAP Type, 125

Encryp Type, 48

End Time, 129

Extension Channel, 41

## F

Factory Default Setting, 167

Fast Roaming, 58

Firmware Upgrade, 106

Force Overload Disassociation, 109

Fragment Length, 50

## G

General Setup, LAN, 87

## H

Hardware Reset, 167

Hide SSID, 41

HTTP port, 103

HTTPS, 127

HTTPS port, 103

## I

Interference Monitor, 158

IP Address, 85, 87

Isolate Member, 42

## **K**

Keep Alive Period, 95

Key Renewal Interval, 44

Key Size, 127

Key Type, 127

## **L**

LAN, 87

LAN port, 90

Lease Time, 88

LED Indicators and Connectors, 2

Limit Client, 40

Limit Client per SSID, 40

Load Balance, 109

## **M**

MAC Address, 84

MAC Address Filter, 47

MAC Clone, 50

Main SSID, 17, 21, 28

Management, 103

Management VLAN, 87

Mobile Device Management, 112

Mode, 41, 43

## **N**

NTP, 128

NTP Client, 101

NTP synchronization, 101

## **O**

Once, 130

Open/Shared, 30, 85

Operation Mode, 34

Overload Management, 109

## **P**

Pass Phrase, 44, 85

Password, 14

Password Strength, 96

Periodic Inform Settings, 95

PIN Code, 37

PMK Cache Period, 58

Policy, 46, 120, 121

Port, 45

Port Control, 90

Pre-Authentication, 58

Primary DNS Server, 88

PSK, 36

Push Button, 48

## **Q**

Quick Start Wizard, 16

## **R**

RADIUS Server, 44, 124

RADIUS Setting, 124

Reboot System, 105

Reconnection Time, 56

Relay Agent, 88

Restore, 47

Roaming, 57

Router Name, 85

Routine, 130

RSSI, 57

RTS Threshold, 50

## **S**

Schedule, 128

Secondary DNS Server, 88

Secret Key, 125

Security, 43

Security Mode, 84

Security Overview, 36

Security Settings, 43

Session Timeout, 45

Shared Secret, 45

Show Chart, 118

Simulate 2 APs, 41

Software Reset, 167

Speed Test, 153

SSL(HTTPS), 95

Start Date, 129

Start PBC, 37

Start Time, 129

Station Control, 18, 21, 28, 55  
Station List, 64  
Status of Settings, 110  
STUN, 95  
Subject Name, 126  
Subnet, 42  
Subnet Mask, 85, 87  
Support Area, 160  
Syslog/Mail Alert, 100  
System Log, 153  
System Maintenance, 92  
System Status, 93

## **T**

Temperature Sensor, 132, 133  
Temperature Sensor Graph, 134  
Time and Date, 101  
TKIP, 30, 36  
Total Download Limit, 53  
Total Upload Limit, 53  
TR-069, 94  
Traffic Graph, 154  
traffic overload, 109

Triggering Client Number, 54  
Trust DHCP Server, 88  
Tx Power, 50

## **U**

Upload Limit, 52  
Users Profile, 125

## **V**

VLAN ID, 42, 87

## **W**

WEP, 30  
WEP (Wired Equivalent Privacy), 36  
White List, 109  
Wi-Fi DOWN, 130  
Wi-Fi UP, 130  
Wireless LAN (2.4GHz/5GHz), 36  
WLAN (2.4GHz) Statistics, 155  
WLAN (5GHz) Statistics, 156, 157  
WPA (Wi-Fi Protected Access), 36  
WPA Algorithms, 44  
WPS, 47  
WPS (Wi-Fi Protected Setup), 36