

NPort® IA5000A Series

1, 2, and 4-port serial device servers for industrial automation



- > Enhanced surge protection for LAN/serial/power
- > 2 kV isolation for serial signals (isolation models)
- > Screw-type terminal blocks for secure power/serial connections
- > C1D2, ATEX, and IECEx certified for harsh industrial environments
- > Cascading Ethernet ports for easy wiring
- > Redundant DC power inputs
- > Warning by relay output and email
- > -40 to 75°C operating temperature range (T models)



Overview

The NPort IA5000A series device servers are designed for connecting industrial automation serial devices, such as PLCs, sensors, meters, motors, drives, barcode readers, and operator displays. The device servers are built solid with a metal housing, screw connectors, and

provide full surge protection. The NPort IA5000A series device servers are extremely user-friendly, making simple and reliable serial-to-Ethernet solutions possible.

Cascading Ethernet Ports Make Wiring Easy (10/100BaseTX models only)

The NPort IA5000A series device servers each have two Ethernet ports that can be used as Ethernet switch ports. One port connects directly to the network or server, and the other port can be connected to either another NPort IA device server or another Ethernet device. The dual Ethernet ports help reduce wiring costs by eliminating the need to connect each device to a separate Ethernet switch.

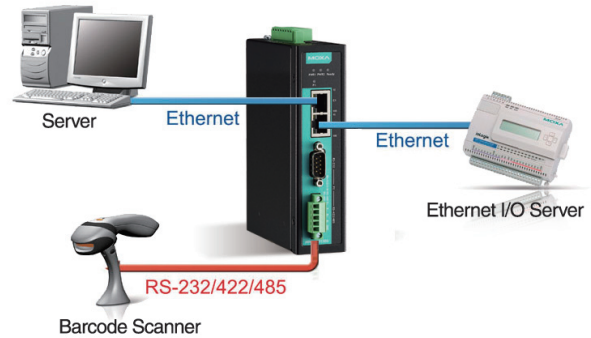

Redundant Power Inputs

The NPort IA5000A series device servers have two power inputs that can be connected simultaneously to live DC power sources. If one power source fails, the other source takes over automatically. Redundant power inputs help ensure uninterrupted operation of your device server.

Dual Power Inputs

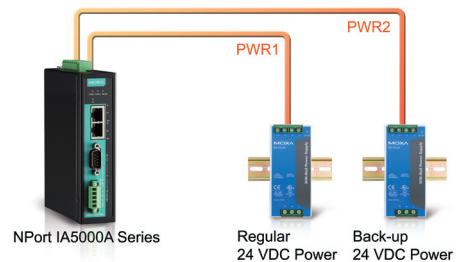

Relay Output Warning and E-mail Alerts

The built-in relay output can be used to alert administrators when the network is down, when power failure occurs, or when there is a change in the DCD or DSR serial signals. An e-mail warning can also be issued when an abnormality is detected. These functions are valuable tools that enable maintenance engineers to react promptly to emergency situations.

Power Failure Alarm

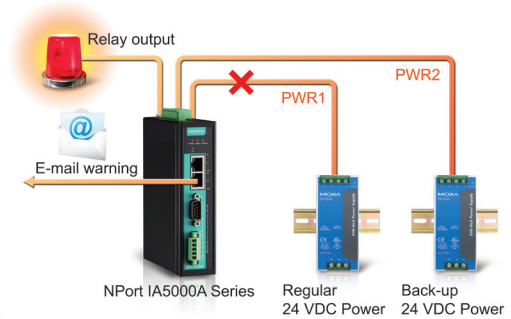

Surge Protection for Serial, LAN, and Power

Moxa's leading-edge surge immunity solution, which is applied to the NPort® IA5000A's serial, power, and Ethernet lines, is tested and proven compliant with IEC 61000-4-5. This advanced surge protection

provides a robust serial-to-Ethernet solution that can protect electrical devices from voltage spikes and resist electrical interference, such as in oil, gas, and power automation applications.

Industrial-Grade Certification

To ensure safe and reliable operation in industrial environments, the NPort® IA5000A device servers have obtained various industrial certifications, including an IP30 rating for mechanical protection and UL 508 safety certification for industrial control equipment. In

addition, these device servers are UL/cUL listed (for Class 1, Division 2, Groups A,B,C,D), ATEX Class 1 Zone 2, and IECEx compliant for use in hazardous locations.

Specifications

Ethernet Interface

Number of Ports: 2
Speed: 10/100 Mbps, auto MDI/MDIX
Connector: 8-pin RJ45
Magnetic Isolation Protection: 1.5 kV built-in
Ethernet Line Protection: 1 kV (level 2) surge protection

Serial Interface

Number of Ports:
 NPort IA5150A: 1
 NPort IA5250A: 2
 NPort IA5450A: 4
Serial Standards: RS-232/422/485
Connector:
 NPort IA5150A: DB9 for RS-232, terminal block for RS-422/485
 NPort IA5250A/IA5450A: DB9 for RS-232/422/485

Serial Line Protection:

- 2 kV isolation protection for isolation models
- 1 kV (level 2) surge protection

RS-485 Data Direction Control: ADDC® (Automatic Data Direction Control)

Serial Communication Parameters

Data Bits: 5, 6, 7, 8
Stop Bits: 1, 1.5, 2
Parity: None, Even, Odd, Space, Mark
Flow Control: RTS/CTS and DTR/DSR (RS-232 only), XON/XOFF
Baudrate: 50 to 921.6 kbps

Serial Signals

RS-232: Tx+, Rx+, RTS, CTS, DTR, DSR, DCD, GND
RS-422: Tx+, Tx-, Rx+, Rx-, GND
RS-485-4w: Tx+, Tx-, Rx+, Rx-, GND
RS-485-2w: Data+, Data-, GND

Software

Network Protocols: ICMP, IPv4, TCP, UDP, DHCP, BOOTP, Telnet, DNS, SNMP, HTTP, SMTP, SNTIP, IGMP, ARP
Configuration Options: Web Console, Serial Console, Telnet Console, Windows Utility
Windows Real COM Drivers: Windows 95/98/ME/NT/2000, Windows XP/2003/Vista/2008/7/8/8.1/10 (x86/x64), Windows 2008 R2/2012/2012 R2 (x64), Windows Embedded CE 5.0/6.0, Windows XP Embedded
Fixed TTY Drivers: SCO Unix, SCO OpenServer, UnixWare 7, QNX 4.25, QNX 6, Solaris 10, FreeBSD, AIX 5.x, HP-UX 11i, Mac OS X
Linux Real TTY Drivers: Linux 2.4.x, 2.6.x, 3.x

Physical Characteristics

Housing: Metal
Weight:
 NPort IA5150A: 475 g (1.05 lb)
 NPort IA5250A: 485 g (1.07 lb)
 NPort IA5450A: 560 g (1.23 lb)

Dimensions:

NPort IA5150A/IA5250A: 36 x 105 x 140 mm (1.42 x 4.13 x 5.51 in)
 NPort IA5450A: 45.8 x 134 x 105 mm (1.8 x 5.28 x 4.13 in)

Environmental Limits

Operating Temperature:
 Standard Models: 0 to 60°C (32 to 140°F)
 Wide Temp. Models: -40 to 75°C (-40 to 167°F)
Storage Temperature: -40 to 75°C (-40 to 167°F)
Ambient Relative Humidity: 5 to 95% (non-condensing)

Power Requirements

Input Voltage: 12 to 48 VDC

Input Current:

- NPort IA5150A: 220 mA @ 12 VDC
- NPort IA5150AI: 225 mA @ 12 VDC
- NPort IA5250A: 250 mA @ 12 VDC
- NPort IA5250AI: 290 mA @ 12 VDC
- NPort IA5450A: 374 mA @ 12 VDC
- NPort IA5450AI: 512 mA @ 12 VDC

Standards and Certifications

Safety: UL 508

Hazardous Location: UL/cUL Class I Division 2 Groups A/B/C/D, ATEX Class I Zone 2, IECEx

EMC: EN 55022/24

EMI: CISPR 22, FCC Part 15B Class A

EMS:

- IEC 61000-4-2 ESD: Contact: 6 kV; Air: 8 kV
- IEC 61000-4-3 RS: 80 MHz to 1 GHz: 10 V/m
- IEC 61000-4-4 EFT: Power: 4 kV; Signal: 2 kV
- IEC 61000-4-5 Surge: Power: 2 kV; Signal: 1 kV
- IEC 61000-4-6 CS: 150 kHz to 80 MHz: 10 V/m; Signal: 10 V/m
- IEC 61000-4-8 PFMF

Freefall: IEC 60068-2-32

Vibration: IEC 60068-2-6

Shock: IEC 60068-2-27

Reliability

Alert Tools: Built-in buzzer and RTC (real-time clock)

Automatic Reboot Trigger: Built-in WDT (watchdog timer)

MTBF (mean time between failures)

Time: 262,805 hrs

Standard: Telcordia (Bellcore) Standard TR/SR

Warranty

Warranty Period: 5 years

Details: See www.moxa.com/warranty

Pin Assignment

RS-232/422/485 DB9 male port

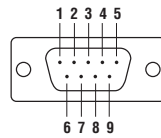

PIN	RS-232	RS-422/RS-485-4w	RS-485-2w
1	DCD	TxD-(A)	-
2	RxD	TxD+(B)	-
3	TXD	RxD+(B)	Data+(B)
4	DTR	RxD-(A)	Data-(A)
5	GND	GND	GND
6	DSR	-	-
7	RTS	-	-
8	CTS	-	-

RS-422/485 Terminal Block Wiring

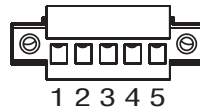

PIN	RS-422/RS-485-4w	RS-485-2w
1	TxD+(B)	-
2	TxD-(A)	-
3	RxD+(B)	Data+(B)
4	RxD-(A)	Data-(A)
5	GND	GND

Dimensions

Unit: mm (inch)

NPort IA5150A NPort IA5150AI **NPort IA5250A NPort IA5250AI**

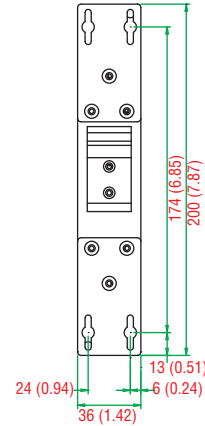
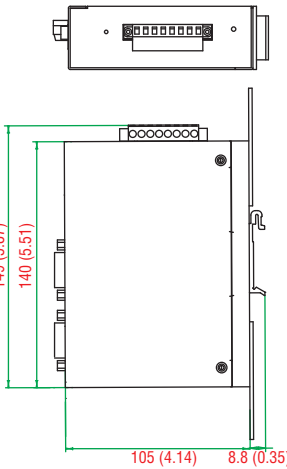
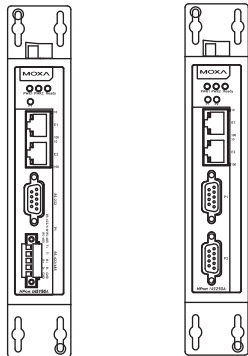

NPort IA5450A NPort IA5450AI

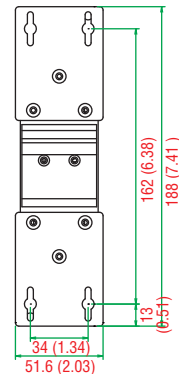
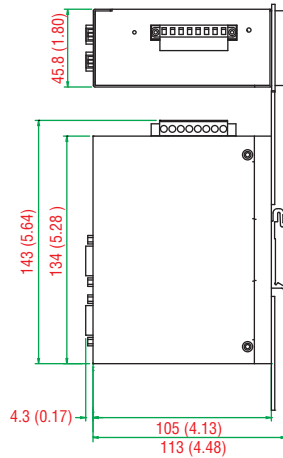
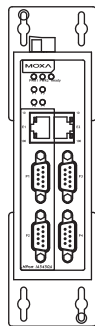

Ordering Information

Available Models

NPort IA5150A: 1-port RS-232/422/485 industrial automation device server with serial/LAN/power surge protection, two 10/100BaseT(X) ports with single IP, 0 to 60°C operating temperature

NPort IA5150AI: 1-port RS-232/422/485 industrial automation device server with serial/LAN/power surge protection, two 10/100BaseT(X) ports with single IP, 2 kV isolation, 0 to 60°C operating temperature

NPort IA5250A: 2-port RS-232/422/485 industrial automation device server with serial/LAN/power surge protection, two 10/100BaseT(X) ports with single IP, 0 to 60°C operating temperature

NPort IA5250AI: 2-port RS-232/422/485 industrial automation device server with serial/LAN/power surge protection, two 10/100BaseT(X) ports with single IP, 2 kV isolation, 0 to 60°C operating temperature

NPort IA5450A: 4-port RS-232/422/485 industrial automation device server with serial/LAN/power surge protection, two 10/100BaseT(X) ports with single IP, 0 to 60°C operating temperature

NPort IA5450AI: 4-port RS-232/422/485 industrial automation device server with serial/LAN/power surge protection, two 10/100BaseT(X) ports with single IP, 2 kV isolation protection, 0 to 60°C operating temperature

NPort IA5150A-T: 1-port RS-232/422/485 industrial automation device server with serial/LAN/power surge protection, two 10/100BaseT(X) ports with single IP, -40 to 75°C operating temperature

NPort IA5150AI-T: 1-port RS-232/422/485 industrial automation device server with serial/LAN/power surge protection, two 10/100BaseT(X) ports with single IP, 2 kV isolation, -40 to 75°C operating temperature

NPort IA5250A-T: 2-port RS-232/422/485 industrial automation device server with serial/LAN/power surge protection, two 10/100BaseT(X) ports with single IP, -40 to 75°C operating temperature

NPort IA5250AI-T: 2-port RS-232/422/485 industrial automation device server with serial/LAN/power surge protection, two 10/100BaseT(X) ports with single IP, 2 kV isolation, -40 to 75°C operating temperature

NPort IA5450A-T: 4-port RS-232/422/485 industrial automation device server with serial/LAN/power surge protection, two 10/100BaseT(X) ports with single IP, -40 to 75°C operating temperature

NPort IA5450AI-T: 4-port RS-232/422/485 industrial automation device server with serial/LAN/power surge protection, two 10/100BaseT(X) ports with single IP, 2 kV isolation protection, -40 to 75°C operating temperature

IECEX Models

NPort IA5150A-IEEX: 1-port RS-232/422/485 industrial automation device server with serial/LAN/power surge protection, two 10/100BaseT(X) ports with single IP, IECEX, 0 to 60°C operating temperature

NPort IA5150AI-IEEX: 1-port RS-232/422/485 industrial automation device server with serial/LAN/power surge protection, two 10/100BaseT(X) ports with single IP, 2 kV isolation, IECEX, 0 to 60°C operating temperature

NPort IA5250A-IEEX: 2-port RS-232/422/485 industrial automation device server with serial/LAN/power surge protection, two 10/100BaseT(X) ports with single IP, IECEX, 0 to 60°C operating temperature

NPort IA5250AI-IEEX: 2-port RS-232/422/485 industrial automation device server with serial/LAN/power surge protection, two 10/100BaseT(X) ports with single IP, 2 kV isolation, IECEX, 0 to 60°C operating temperature

NPort IA5450A-IEEX: 4-port RS-232/422/485 industrial automation device server with serial/LAN/power surge protection, two 10/100BaseT(X) ports with single IP, IECEX, 0 to 60°C operating temperature

NPort IA5450AI-IEEX: 4-port RS-232/422/485 industrial automation device server with serial/LAN/power surge protection, two 10/100BaseT(X) ports with single IP, 2 kV isolation protection, IECEX, 0 to 60°C operating temperature

NPort IA5150A-T-IEEX: 1-port RS-232/422/485 industrial automation device server with serial/LAN/power surge protection, two 10/100BaseT(X) ports with single IP, IECEX, -40 to 75°C operating temperature

NPort IA5150AI-T-IEEX: 1-port RS-232/422/485 industrial automation device server with serial/LAN/power surge protection, two 10/100BaseT(X) ports with single IP, 2 kV isolation, IECEX, -40 to 75°C operating temperature

NPort IA5250A-T-IEEX: 2-port RS-232/422/485 industrial automation device server with serial/LAN/power surge protection, two 10/100BaseT(X) ports with single IP, IECEX, -40 to 75°C operating temperature

NPort IA5250AI-T-IEEX: 2-port RS-232/422/485 industrial automation device server with serial/LAN/power surge protection, two 10/100BaseT(X) ports with single IP, 2 kV isolation, IECEX, -40 to 75°C operating temperature

NPort IA5450A-T-IEEX: 4-port RS-232/422/485 industrial automation device server with serial/LAN/power surge protection, two 10/100BaseT(X) ports with single IP, IECEX, -40 to 75°C operating temperature

NPort IA5450AI-T-IEEX: 4-port RS-232/422/485 industrial automation device server with serial/LAN/power surge protection, two 10/100BaseT(X) ports with single IP, 2 kV isolation protection, IECEX, -40 to 75°C operating temperature

Optional Accessories (can be purchased separately)

Mini DB9F-to-TB: DB9 female to terminal block adapter for RS-422/485 applications



WK-36-02: Wall-mounting kit for the NPort IA5150A/IA5250A

WK-51-01: Wall-mounting kit for the NPort IA5450A

Package Checklist

- 1 NPort IA5000A series device server
- Documentation and software CD
- Quick installation guide (printed)
- Warranty card

Power Accessory Selection Guide

Barrel Plug Type		Locking Barrel Plug				
O/P		12 VDC 0.5 A, 100 to 240 VAC (Switch-Mode)				
Plug Type		US/JP	EU	AU	UK	CN
Appearance						
Model Name		PWR-12050-WPUSJP-S1	PWR-12050-WPEU-S1	PWR-12050-WPAU-S1	PWR-12050-WPUK-S1	PWR-12050-WPCN-S1
1 Port	NPort 5110	-	-	-	-	-
	NPort 5130	-	-	-	-	-
	NPort 5150	-	-	-	-	-
	NPort 5110A	✓	✓	✓	✓	✓
	NPort 5130A	✓	✓	✓	✓	✓
	NPort 5150A	✓	✓	✓	✓	✓
	DE-211	-	-	-	-	-
	DE-311	-	-	-	-	-
	NPort P5150A	✓	✓	✓	✓	✓
	NPort W2150A	✓	✓	✓	✓	✓
NPort Z2150/Z3150	✓	✓	✓	✓	✓	
2 Ports	NPort 5210	-	-	-	-	-
	NPort 5230	-	-	-	-	-
	NPort 5232	-	-	-	-	-
	NPort 5232I	-	-	-	-	-
	NPort 5210A	✓	✓	✓	✓	✓
	NPort 5230A	✓	✓	✓	✓	✓
	NPort 5250A	✓	✓	✓	✓	✓
	NPort W2250A	✓	✓	✓	✓	✓

Barrel Plug Type		Non-Locking Barrel Plug				
O/P		12 VDC 0.5 A, 100 to 240 VAC (Switch-Mode)				
Plug Type		US/JP	EU	AU	UK	CN
Appearance						
Model Name		PWR-12050-WPUSJP-S2	PWR-12050-WPEU-S2	PWR-12050-WPAU-S2	PWR-12050-WPUK-S2	PWR-12050-WPCN-S2
1 Port	NPort 5110	✓	✓	✓	✓	✓
	NPort 5130	✓	✓	✓	✓	✓
	NPort 5150	✓	✓	✓	✓	✓
	NPort 5110A	-	-	-	-	-
	NPort 5130A	-	-	-	-	-
	NPort 5150A	-	-	-	-	-
	DE-211	✓	✓	✓	✓	✓
	DE-311	✓	✓	✓	✓	✓
	NPort P5150A	-	-	-	-	-
	NPort W2150A	-	-	-	-	-
NPort Z2150/Z3150	-	-	-	-	-	
2 Ports	NPort 5210	✓	✓	✓	✓	✓
	NPort 5230	✓	✓	✓	✓	✓
	NPort 5232	✓	✓	✓	✓	✓
	NPort 5232I	✓	✓	✓	✓	✓
	NPort 5210A	-	-	-	-	-
	NPort 5230A	-	-	-	-	-
	NPort 5250A	-	-	-	-	-
	NPort W2250A	-	-	-	-	-

Power Accessory Selection Guide

Barrel Plug Type		Non-Locking Barrel Plug				
O/P		12 VDC 1.25/1.5 A, 100 to 240 VAC				
Plug Type		US/JP	EU	AU	UK	CN
Appearance						
Model Name		PWR-12125-USJP-S1	PWR-12150-EU-S2	PWR-12150-AU-S2	PWR-12150-UK-S2	PWR-12125-CN-S1
4 Ports	NPort 5410	✓	✓	✓	✓	✓
	NPort 5430	✓	✓	✓	✓	✓
	NPort 5430I	✓	✓	✓	✓	✓
	NPort 5450	✓	✓	✓	✓	✓
	NPort 5450I	✓	✓	✓	✓	✓
8 Ports	NPort 5610-8	-	-	-	-	-
	NPort 5630-8	-	-	-	-	-
	NPort 5650-8	-	-	-	-	-
	NPort 5650-8-M-SC	-	-	-	-	-
	NPort 5650-8-S-SC	-	-	-	-	-
	NPort 5610-8-DT	-	-	-	-	-
	NPort 5610-8-DT-J	-	-	-	-	-
	NPort 5650-8-DT	-	-	-	-	-
	NPort 5650-8-DT-J	-	-	-	-	-
	NPort 5650I-8-DT	-	-	-	-	-
	NPort 5610-8-DTL	-	-	-	-	-
NPort 5650-8-DTL	-	-	-	-	-	
16 Ports	NPort 5610-16	-	-	-	-	-
	NPort 5630-16	-	-	-	-	-
	NPort 5650-16	-	-	-	-	-

Barrel Plug Type		Locking Barrel Plug						
O/P		12 VDC 2 A, 100 to 240 VAC (desktop type)	10A/250V Power Cord, 183 cm					
Plug Type		Must accompany with one power cord	US	JP	EU	AU	UK	CN
Appearance								
Model Name		PWR-12200-DT-S1	PWC-C13US-3B-183	PWC-C13JP-3B-183	PWC-C13EU-3B-183	PWC-C13AU-3B-183	PWC-C13UK-3B-183	PWC-C13CN-3B-183
4 Ports	NPort 5410	-	-	-	-	-	-	-
	NPort 5430	-	-	-	-	-	-	-
	NPort 5430I	-	-	-	-	-	-	-
	NPort 5450	-	-	-	-	-	-	-
	NPort 5450I	-	-	-	-	-	-	-
8 Ports	NPort 5610-8	-	✓	✓	✓	✓	✓	✓
	NPort 5630-8	-	✓	✓	✓	✓	✓	✓
	NPort 5650-8	-	✓	✓	✓	✓	✓	✓
	NPort 5650-8-M-SC	-	✓	✓	✓	✓	✓	✓
	NPort 5650-8-S-SC	-	✓	✓	✓	✓	✓	✓
	NPort 5610-8-DT	✓	✓	✓	✓	✓	✓	✓
	NPort 5610-8-DT-J	✓	✓	✓	✓	✓	✓	✓
	NPort 5650-8-DT	✓	✓	✓	✓	✓	✓	✓
	NPort 5650-8-DT-J	✓	✓	✓	✓	✓	✓	✓
	NPort 5650I-8-DT	✓	✓	✓	✓	✓	✓	✓
	NPort 5610-8-DTL	✓	✓	✓	✓	✓	✓	✓
NPort 5650-8-DTL	✓	✓	✓	✓	✓	✓	✓	
16 Ports	NPort 5610-16	-	✓	✓	✓	✓	✓	✓
	NPort 5630-16	-	✓	✓	✓	✓	✓	✓
	NPort 5650-16	-	✓	✓	✓	✓	✓	✓